

rdi[®]
RAILING

2023 CATALOG



BY Barrette
OUTDOOR LIVING[®]



THE OUTSIDE COMPANY™



Get outside and live your best life

We realize that inside each of us, there is an Outside Side™ — a side begging to get out there, to be outgoing, to break out of our same old inside routines and to outdo ourselves with our outdoor space. At Barrette Outdoor Living, we help your Outside Side run free with products that constantly beckon you out there. We know there is an Outside Side in everyone and we're firm believers that it's our best side because we're The Outside Company™.

Your vision

Your home is more than just a space. It's where you raise a family. It's where friends gather, and seasons come and go. It is a living, breathing picture of your life. With our diverse and flexible range of outdoor living solutions, Barrette Outdoor Living can help you bring any vision to life.

Our mission

Barrette Outdoor Living strives to be the best in product design and innovation, inspired by those who work with and for us to create superior outdoor living solutions both professionals and homeowners demand. At the core of our business is a place where integrity, ingenuity and skill meet.



Our promise to you

At Barrette Outdoor Living, we believe in making things right. We proudly stand behind our products by providing dedicated support, superior customer service and product warranties that feature some of the most comprehensive coverage in the industry. With decades of experience behind us, we are quite confident in the craftsmanship and quality of our products, but we also realize things happen. If that thing happens, we promise to make it right within the constraints of our warranties.



Leading the way



Crafting quality



Making it right



Being responsible

Barrette Outdoor Living can help make your outdoor vision a reality. Proud to be an American manufacturer, we produce and distribute fencing, railing, decking and complementary outdoor products. **To learn more, visit us at barretteoutdoorliving.com/warranty**



Barrette Outdoor Living's most premium collection of railing with the widest range of materials, designs and profiles — perfect for both residential and commercial settings.

Versatility in design

RDI® Railing — available in vinyl, aluminum, steel and composite — with its ability to mix-and-match, allows for a wide range of customized options. RDI Railing products feature a variety of infill options, including modern cable, contemporary glass, design-forward Decorative Screen Panels (DSPs) and traditional balusters. If you want a more secluded space, our modern privacy railing comes in a variety of colors and can be further customized by adding DSPs in the top section. Complete your project by adding solar post caps and our easy-to-install LED lighting system.



Code compliant

RDI railings meet or exceed building requirements and are code compliant. Our ADA handrails ensure safety for everyone.



Easy to install

RDI railings either come pre-assembled or require minimal assembly, making our railing easy to install.



Warranty

RDI railings are made with durable materials and are backed by our Transferable Limited Lifetime Warranty* — as a part of our promise to you.



Table of Contents

RDI RAILING

NEW! ELEVATION™ RAIL	6
PRIVACY RAIL™	10
AVALON ALUMINUM RAILING®	16
METALWORKS EXCALIBUR®	28
TRANSFORM®	36
ENDURANCE® ORIGINAL RAIL™	44
FINYL LINE™	54
TITAN PRO RAIL®	68

COMPLEMENTARY ACCENTS

VINYL ADA HANDRAIL	76
ALUMINUM ADA HANDRAIL	80
LIGHTING	84
DECORATIVE SCREEN PANELS	88
LATTICE	92

ELEVATION™ RAIL

Available in pre-assembled kits that installs 38% faster than the competition* — and easy to shop with fewer SKUs — DIY-friendly Elevation Rail requires no special tools. Offering a modern, industrial design and a continuous top rail, this horizontal cable railing offers unobstructed views. Elevation Rail features adjustable panels that span up to 6' wide and the OneTen™ built-in centralized tensioning system.

**Based on a 12' x 18' deck with 8 posts and 7 panels (Elevation installed 49 minutes faster than competitive cable railing install of 129 minutes).*



PRODUCT BENEFITS

- Installs 38% faster than the competition*
- Pre-assembled panels with pre-installed brackets and pre-strung, continuous stainless steel cables
- Centralized tensioning system eliminates the need to tension each cable individually
- Code compliant

HOMEOWNER BENEFITS

- Cable infill provides unobstructed views
- Easy to maintain
- Premium powder coating on aluminum framing meets or exceeds AAMA 2604 specifications
- Transferable Limited Lifetime Warranty on aluminum rails and posts. Limited Warranty on cable fittings.

DESIGN VERSATILITY

- Modern, industrial design with a sleek continuous top rail for both level and stair applications
- Can be used outdoors or indoors



Matte Black

**Based on a 12' x 18' deck with 8 posts and 7 panels (Elevation installed 49 minutes faster than competitive cable railing install of 129 minutes).*



ONETEN™

The OneTen built-in tensioning control system eliminates the need to tension each cable individually and decreases the need for seasonal adjustments.



SOLARGUARD®

SolarGuard is a material composition that provides fade resistance* so that your outdoor living products will look good for years to come.

*Does not apply to white vinyl products.



Elevation Rail in Matte Black.

HOW TO SHOP:

LEVEL RAIL PANELS

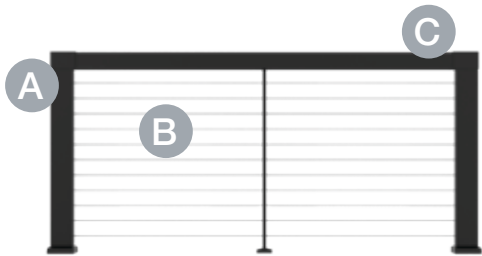

- A** Pre-slotted level end, mid and corner cable posts accept cable level rail panels. Post caps included for for seamless panel transitions.
- B** Cable rail panel fits securely into posts and includes mid-rail support and OneTen tensioning system.
- C** Beam kit includes top beam and top rail to complete your panel.

STAIR RAIL PANELS

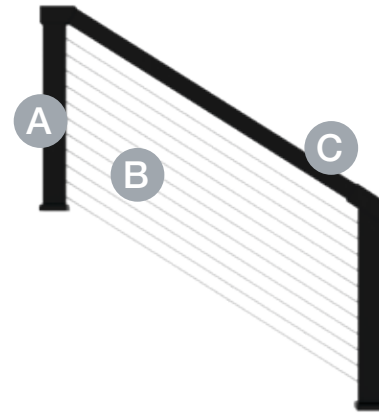

- A** Pre-slotted stair end and mid cable posts accept cable stair rail panels. Post caps included for for seamless panel transitions.
- B** Cable rail panel fits securely into posts and includes OneTen tensioning system.
- C** Beam kit includes top beam and top rail to complete your panel.

CABLE RAIL – POSTS

Description	Matte Black
2" x 4" x 36" End Post	73053488
2" x 4" x 36" Mid Post	73053489
4" x 4" x 36" Corner Post	73053490
2" x 4" x 38" End Stair Post	73053491
2" x 4" x 38" Mid Stair Post	73053492

Posts include post, connected base plate, sandwich plate, trim ring and post cap.



CABLE RAIL – PANELS

Description	Matte Black
6' x 36" Level Cable Panel	73053485
5' x 36" Stair Cable Panel	73053486

Includes cable infill section, center support and cable tensioner. Top beam kit sold separately.



CABLE RAIL – BEAM KIT

Description	Matte Black
6' Top Beam Kit	73053487

Includes top beam and top rail.



PRIVACY RAIL™

Privacy Rail provides a contemporary and modern look for decks or patios while offering the option of increased privacy for outdoor spaces. Powder coated aluminum framing provides strength and stability while a selection of vinyl infill boards lock securely together using our patented ClickConnect™ technology. An adapter kit that allows Decorative Screen Panels to be inserted into framing is also available — offering greater customization and design options.



PRODUCT BENEFITS

- Easy to assemble
- Vinyl infill boards lock securely together and fit tightly in post channels
- Code compliant
- Made in the USA

HOMEOWNER BENEFITS

- Easy to maintain
- Premium powder coating on aluminum rail kits and posts meets and exceeds AAMA 2604 specifications
- Advanced weather testing, including 10,000 hours of salt spray testing
- Transferrable Limited Lifetime Warranty

DESIGN VERSATILITY

- Adapter kit available to add Decorative Screen Panels* to framing
- Complements other vinyl or aluminum railing products
- Rail kits and posts available in 2 colors



Matte Black

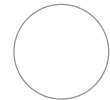

White

- Vinyl infill boards* available in 5 colors

NEW!

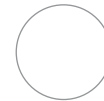

White



Clay



Sand



Gray



Driftwood

*Decorative Screen Panels and vinyl infill boards sold separately.



CLICKCONNECT™

ClickConnect is a patented connecting system that locks vinyl infill boards tightly together to create a railing panel that meets code compliance.



SOLARGUARD®

SolarGuard is a material composition that provides fade resistance* so that your outdoor living products will look good for years to come.

*Does not apply to white vinyl products.



HOW TO SHOP:

FULL PRIVACY PANEL WITH VINYL INFILL BOARDS



FULL PRIVACY WITH DECORATIVE SCREEN PANEL AND VINYL INFILL BOARDS

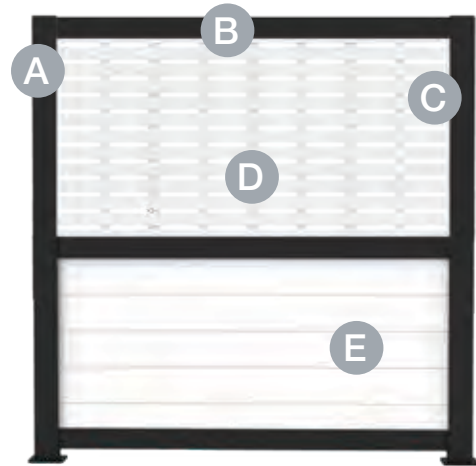

- A** 72" posts for full privacy height – available as end, corner and mid.
- B** Rail Kits – includes top, bottom, mid rails and post inserts for vinyl infill boards.
- C** Vinyl infill boards (requires a total of 11 boards – either 5 or 6 on top or bottom).

- A** 72" posts for full privacy height – available as end, corner and mid posts.
- B** Rail Kits – includes top, bottom, mid rails and post inserts for vinyl infill boards (E).
- C** Adapter Kit for Decorative Screen Panel – includes post inserts for Decorative Screen Panels (sold separately).
- D** Decorative Screen Panel.
- E** Vinyl infill boards.

HALF PRIVACY PANEL WITH VINYL INFILL BOARDS



- A** 42" post height for half privacy – can be installed for 42" finished height or cut down for 36" finished height. Available as corner, mid and end posts.
- B** Rail Kits – includes top and bottom rail and post inserts for vinyl infill boards.
- C** Vinyl infill boards – 5 needed for 36" finished height, 6 needed for 42" finished height.

RAIL KITS

Description	White	Matte Black
6' Wide Full Privacy Rail Kit (includes top rail, bottom rail and mid rail)	73042844	73042828
6' Wide Half Privacy Rail Kit (includes top rail and bottom rail)	73042845	73042827

Full Privacy Rail kits include top and bottom rails and mid rail. Half Privacy Rail kits include top and bottom rail. Infill boards sold separately.

Full privacy panel requires 11 infill boards, half privacy requires 5 for 36" finished height or 6 for 42" finished height. An installed section using 2 end posts measures a finished width of 6'. If advanced wind load (check local codes) requirements are necessary, then full privacy railing (6' tall) must have post spacing every 3'.

ADAPTER KITS FOR DECORATIVE SCREEN PANELS

Description	White	Matte Black
3' x 6' Privacy Rail Adapter Kit (includes top, bottom and side insert adapters)	73044016	73044015

Adapter kit allows for 3' x 6' Decorative Screen Panels (sold separately) to be used as infills (can be used on top or bottom of Full Privacy Rail Kit, or with Half Privacy Rail Kit). See page 88 for all 3' x 6' Decorative Screen Panel options.



Full Privacy Panel
(with vinyl infill boards)



Full Privacy Panel (with Decorative
Screen Panel and vinyl infill boards)



Half Privacy Panel
(with vinyl infill boards)

POSTS

Description	White	Matte Black
2" x 4" x 42" End Post – Surface Mount	73042839	73042834
2" x 4" x 42" Mid Post – Surface Mount	73042840	73042832
3.3" x 3.3" x 42" Corner Post – Surface Mount	73042838	73042833
2" x 4" x 72" End Post – Surface Mount	73042842	73042837
2" x 4" x 72" Mid Post – Surface Mount	73042843	73042835
3.3" x 3.3" x 72" Corner Post – Surface Mount	73042841	73042836

Posts come with pre-mounted base plates, 2-piece trim rings, infill board adapters*, post hardware covers, channel cover** and flat caps.

*42" posts do not include 27" infill adapter channels.

** 36" channel cover included in 72" posts only for a finished look transitioning from full to half privacy.



2" x 4" End Post



2" x 4" Mid Post



3.3" x 3.3" Corner Post

A post is needed at each end of your Privacy Rail panels. End posts can also be used to transition from privacy to our vinyl or aluminum railing. 42" posts can be used for half privacy sections 36" or 42", and 72" posts are used for full privacy sections.

VINYL INFILL BOARDS

Description	
6" x 66" Vinyl Infill Boards for 6' Width – Pack of 6 – White	73042846
6" x 66" Vinyl Infill Boards for 6' Width – Pack of 6 – Clay	73054363
6" x 66" Vinyl Infill Boards for 6' Width – Pack of 6 – Sand	73043491
6" x 66" Vinyl Infill Boards for 6' Width – Pack of 6 – Gray	73044977
6" x 66" Vinyl Infill Boards for 6' Width – Pack of 6 – Driftwood	73044978

Select color availability may vary. Please check with your dealer for full color availability.

GATE KITS

Description	White	Matte Black
36" Height Gate Kit for Widths 36" – 48"	73044982	73044979
42" Height Gate Kit for Widths 36" – 48"	73045453	73044980
72" Height Gate Kit for Widths 36" – 48"	73045454	73044981
Gravity Latch	73025491	73028060
Two-Sided Locking Latch	73050188	73050187

Gate kits include uprights, top and bottom rails and gate hinges. 36" and 42" gate kits include compact butterfly hinges and 72" gate kit includes heavy-duty hinges, color matched to gate. Purchase your gate latch separately. Infill boards sold separately; 5 boards needed for 36" high gate kits, 6 boards needed for 42" high gate kits and 11 boards needed for 72" high gate kits. Boards and rails must be cut to desired width for finished gate width (36" to 48").



Full Privacy Gate (72")



Half Privacy Gate (36" or 42")

TOUCH-UP PAINT

Description	White	Matte Black
Touch-Up Paint Aerosol (12 oz)	73022328	73044481
Touch-Up Paint Pen (1/3 fl oz)	73022351	N/A
Touch-Up Paint Bottle & Brush (1/2 fl oz)	N/A	73044483

AVALON ALUMINUM RAILING®

Rust-resistant Avalon Aluminum Railing provides style, versatility and safety. The pre-assembled rail panels feature ProLock® locking strips that are designed to hold balusters securely in place. The ultimate in customization, Avalon Aluminum Railing offers four top rail options, including an adapter piece that easily creates a distinctive 3 rail design. Traditional square balusters, glass slats, cable infills and Decorative Screen Panels are available as rail infills.



PRODUCT BENEFITS

- Panels with square balusters come pre-assembled
- Adapter available to convert railing from 36" to 42" for commercial applications
- Unique pre-assembled 2-to-3 Rail Adapter* easily attaches for distinctive 3 rail design
- Code compliant
- Assembled in the USA

*2-to-3 Rail Adapter sold separately.

HOMEOWNER BENEFITS

- Cable and glass slat infill options provide unobstructed views
- Easy to maintain
- Premium powder coating on aluminum framing meets and exceeds AAMA 2604 specifications
- Advanced weather testing, including 10,000 hours of salt spray testing
- Transferrable Limited Lifetime Warranty

DESIGN VERSATILITY

- Decorative Screen Panel infill option offers increased customization with multiple designs and colors
- Mix and match — perfect complement to Transform® Composite Railing
- 3 top rail options
- 4 infill options
- Available in 3 colors



Matte Black

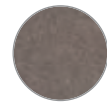

Matte Bronze

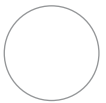

White



PROLOCK®

ProLock is a locking strip that secures railings by connecting them from the inside out to provide a clean design.



SOLARGUARD®

SolarGuard is a material composition that provides fade resistance* so that your outdoor living products will look good for years to come.

*Does not apply to white vinyl products.

Product Spotlight

Decorative Screen Panels can now be used as a code compliant infill for Avalon Aluminum Railing.



HOW TO SHOP:

CABLE INFILL

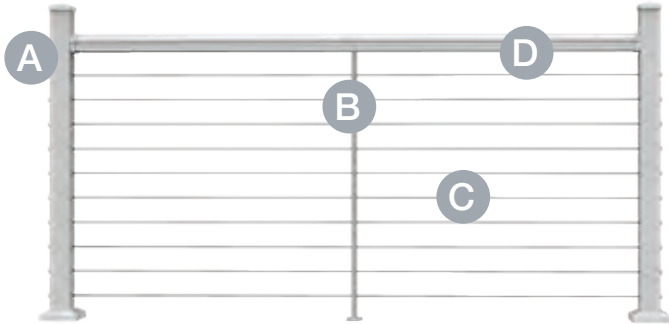

- A** Routed cable posts – end, mid and corner options (includes base and post cap).
- B** Beam Kits – includes top beam, 4 brackets and mid-baluster support.
- C** Cable with fitting – 10 needed for 36" finished heights, 12 needed for 42" finished heights. Available in 10', 20', 30', 50' and 70' lengths.
- D** Top rail – 3 style options.

SQUARE BALUSTERS

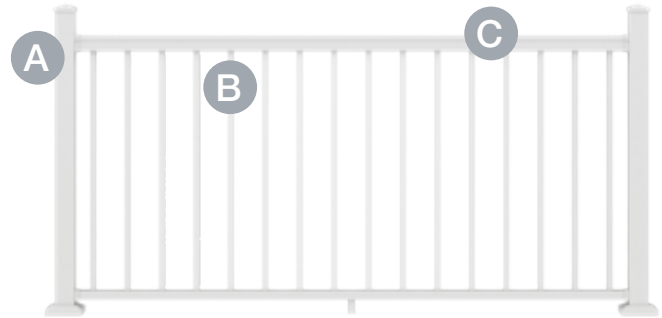

- A** Standard aluminum posts – 2½" (includes base and post cap) or 4¼" (base and post cap sold separately) options.
- B** Pre-assembled level and stair rail sections. Includes 4 brackets and a support foot.
- C** Top rail – 3 style options.

DECORATIVE SCREEN PANEL INFILL



- A** Standard aluminum posts – 2½" (includes base and post cap) or 4¼" (base and post cap sold separately) options.
- B** Beam Kits – includes top beam, bottom rail, Decorative Screen Panel uprights, brackets and support foot.
- C** 3' x 6' Decorative Screen Panel infill – available in 4 styles and a variety of color combinations.
- D** Top rail – 3 style options.

GLASS BALUSTERS

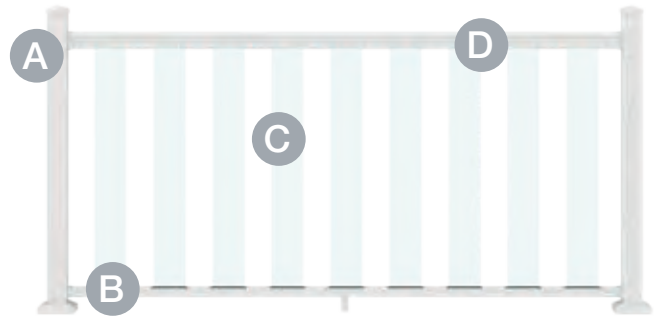

- A** Standard aluminum posts – 2½" (includes base and post cap) or 4¼" (base and post cap sold separately) options.
- B** Beam Kits – 6' and 8' for 36" and 42" finished heights, level only. Includes 4 brackets and support foot.
- C** Glass slat infill – 9 needed for 6' sections, 12 needed for 8' sections. Available for 36" and 42" finished heights, level only.
- D** Top rail – 3 style options.

ALUMINUM 2½" X 2½" ROUTED CABLE POSTS			
Description	White	Matte Black	Matte Bronze
2½" x 2½" x 39" End Post	73042977	73042976	73042978
2½" x 2½" x 39" Mid Post	73042983	73042982	73042984
2½" x 2½" x 39" Corner Post	73042995	73042994	73042996
2½" x 2½" x 39" Top Stair Post	73050039	73050038	73050040
2½" x 2½" x 42" Bottom Stair Post	73045616	73045615	73045617
2½" x 2½" x 42" Mid Stair Post	73050045	73050044	73050046
2½" x 2½" x 45" End Post	73042980	73042979	73042981
2½" x 2½" x 45" Mid Post	73042986	73042985	73042987
2½" x 2½" x 45" Corner Post	73042998	73042997	73042999
2½" x 2½" x 45" Top Stair Post	73050042	73050041	73050043
2½" x 2½" x 48" Bottom Stair Post	73045619	73045618	73045620
2½" x 2½" x 48" Mid Stair Post	73050048	73050047	73050049
2½" x 2½" x 52" Fascia End Post	73045622	73045621	73045623
2½" x 2½" x 52" Fascia Mid Post	73045628	73045627	73045629
2½" x 2½" x 52" Fascia Corner Post	73045625	73045624	73045626
2½" x 2½" x 52" Fascia Top Stair Post	73050051	73050050	73050052
2½" x 2½" x 55" Fascia Bottom Stair Post	73050079	73050077	73050080
2½" x 2½" x 55" Fascia Mid Stair Post	73050054	73050053	73050055

42" stair posts are designed to work with 39" top stair posts. 48" stair posts are designed to work with 45" top stair and level posts. 52" and 55" posts are for 42" fascia applications only.



Routed End Post

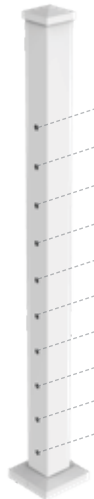

Routed Mid Post



Routed Corner Post

Use end, mid and corner posts for level applications. End posts have routed holes through post to anchor fitting at an end run of cable. Stair and fascia posts are also available. Posts include post, connected base plate, sandwich plate, trim ring and post cap.

CABLE RAIL BEAM KITS

Description	White	Matte Black	Matte Bronze
6' x 36" Level Rail Beam Kit for Cable Rail	73042965	73042964	73042966
8' x 36" Level Rail Beam Kit for Cable Rail	73042968	73042967	73042969
6' x 42" Level Rail Beam Kit for Cable Rail	73050027	73050026	73050028
8' x 42" Level Rail Beam Kit for Cable Rail	73050030	73050029	73050031
6' Stair Rail Beam Kit for Cable Rail	73050033	73050032	73050034
8' Stair Rail Beam Kit for Cable Rail	73050036	73050035	73050037

Stair beam kits can accommodate both 36" and 42" finished heights. See product instructions for details. Cable components and Top Rail sold separately. See page 24 for Top Rail styles.

CABLE COMPONENTS

Description	
10' Cable with Fitting – Package of 1	73042960
20' Cable with Fitting – Package of 1	73042961
30' Cable with Fitting – Package of 1	73042962
50' Cable with Fitting – Package of 1	73042963
70' Cable with Fitting – Package of 1	73050296
Level Cable Lacing Needle	73050056
Corner Cable Lacing Needle	73050057
Cable Release Key	73025484
Cable Gripper Tool – Package of 2	73050244
E-Z Clean Cable Cleaner and Protectant	73040274

For a finished rail height of 36", 10 packages of cable with fitting will be needed. For a finished rail height of 42", 12 packages of cable with fitting will be needed.

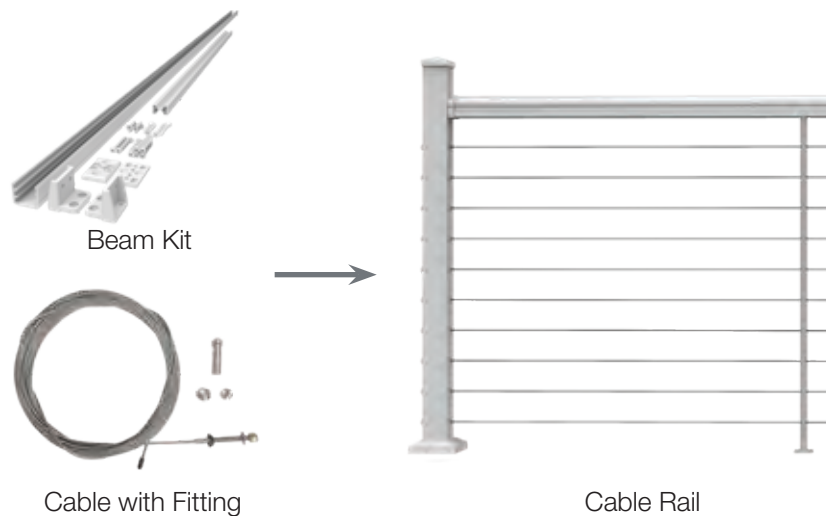

ALUMINUM 2½" X 2½" STANDARD POSTS			
Description	White	Matte Black	Matte Bronze
2½" x 2½" x 39" Post	73043054	73043046	73043050
2½" x 2½" x 45" Post	73043055	73043047	73043051
2½" x 2½" x 45" Heavy Duty Post	73043056	73043048	73043052
2½" x 2½" x 60" Heavy Duty Post	73043057	73043049	73043053
2½" x 2½" x 45" Fascia Mount Post*	73045504	73045503	73045505
2½" x 2½" x 52" Fascia Mount Post*	73045501	73045500	73045502
2½" x 2½" x 65" Post Extension	73050521	73050520	73050522

Standard posts include post, connected base plate, sandwich plate, trim ring and post cap.

*Brackets to install fascia mount posts for end, mid or corner applications sold separately. See page 27 for fascia brackets.

Post Extension fits into 2½" standard posts to extend the height of the post to allow for patio lights to be hung above the railing.

2" X 2" OVER-THE-TOP POSTS			
Description	White	Matte Black	Matte Bronze
2" x 2" x 33" Over-the-Top Post (for 36" finished height)	73020642	73020646	73019470
2" x 2" x 39" Over-the-Top Post (for 42" finished height)	73020643	73020647	73019471

Avalon panels must be cut up to 4" shorter than top rails pending install application. For 42" commercial height, over-the-top spans cannot exceed 5' in length between posts. Brackets sold separately – see page 25.

ALUMINUM 4¼" X 4¼" POSTS/SLEEVES			
Description	White	Matte Black	Matte Bronze
4¼" x 4¼" x 39" Post	73041379	73041378	73041376
4¼" x 4¼" x 45" Post	73041383	73041382	73041380
4¼" x 4¼" x 108" Porch Post – 5,000 lb capacity	73041375	73041374	73041372

4¼" x 4¼" x 108" post sleeves can be used as porch columns (5,000 lb load capacity); two mounting kits will be needed in this application.

ALUMINUM 4¼" X 4¼" POST/SLEEVE ACCESSORIES			
Description	White	Matte Black	Matte Bronze
Flat Post Cap for 4¼" x 4¼" Posts	73041367	73041366	73041364
Trim Ring for 4¼" x 4¼" Posts	73041371	73041370	73041368
Mounting Kit for 4¼" x 4¼" Posts (includes trim ring and mounting plate)	73041363	73041362	73041360

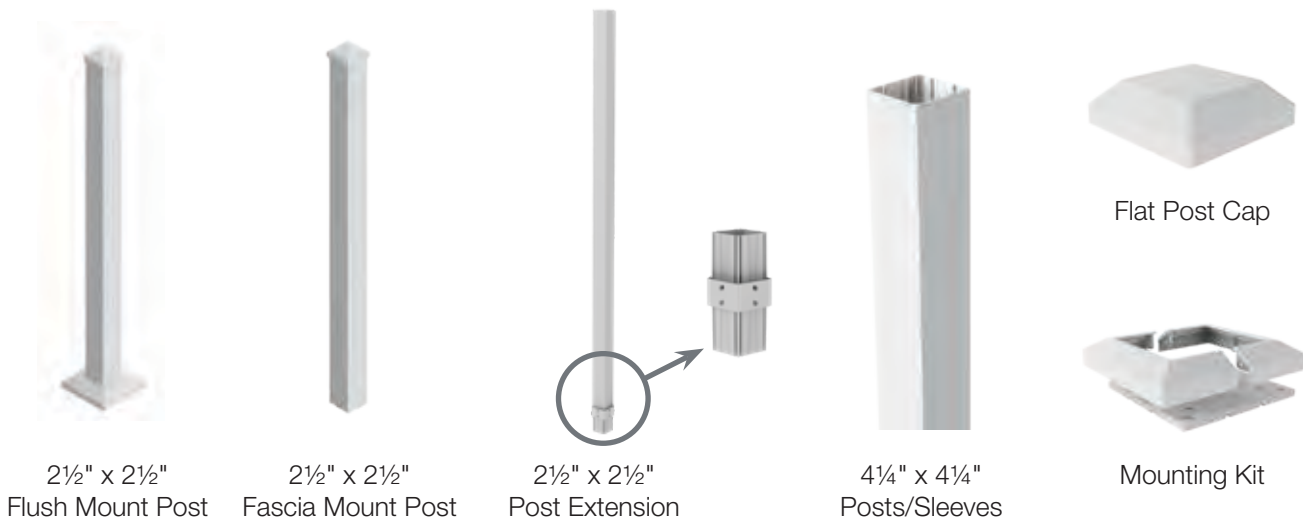

2½" x 2½"
Flush Mount Post

2½" x 2½"
Fascia Mount Post

2½" x 2½"
Post Extension

4¼" x 4¼"
Posts/Sleeves

Flat Post Cap

Mounting Kit

LEVEL RAIL PANELS

Description	White	Matte Black	Matte Bronze
6' x 36" Level Rail Panel with Square Balusters	73019269	73019285	73019458
8' x 36" Level Rail Panel with Square Balusters	73019270	73019286	73019464
6' x 42" Level Rail Panel with Square Balusters	73019273	73019289	73019459
8' x 42" Level Rail Panel with Square Balusters	73019274	73019290	73019465

STAIR RAIL PANELS

Description	White	Matte Black	Matte Bronze
6' x 36" Stair Rail Panel with Square Balusters	73019271	73019287	73019466
8' x 36" Stair Rail Panel with Square Balusters	73019272	73019288	73019468
6' x 42" Stair Rail Panel with Square Balusters	73019275	73019291	73019467
8' x 42" Stair Rail Panel with Square Balusters	73019276	73019292	73019469

Rail panels include bracket kit (two top and two bottom brackets) and support foot with mounting hardware. Top rail sold separately – see page 24.

2-TO-3 RAIL ADAPTER

Description	White	Matte Black	Matte Bronze
6' Rail Adapter	73050440	73050438	73050442
8' Rail Adapter	73050441	73050439	73050443

Adapter includes bracket kit (two top and two bottom brackets) with bracket covers and mounting hardware.



¾" Square Balusters



¾" Square Balusters with 2-to-3 Rail Adapter



BEAM KITS FOR DECORATIVE SCREEN PANEL INFILL

Description	White	Matte Black	Matte Bronze
6' x 36" Beam Kit for 3' x 6' Decorative Screen Panels (sold separately)	73044011	73044009	73044010

Beam kits include top beam, bottom rail, bracket kit (4 level brackets and mounting hardware) and support foot.

See page 90 for all 3' x 6' Decorative Screen Panel options.

GLASS LEVEL RAIL KITS

Description	White	Matte Black	Matte Bronze
6' Beam Kit for Glass Slats (level only)	73020648	73020652	73019454
8' Beam Kit for Glass Slats (level only)	73020649	73020653	73019460

6' kits require 9 glass slats and 8' kits require 12 glass slats (sold separately). Top beam, bottom rail, bracket kit (4 level brackets and mounting hardware), support foot and top and bottom gaskets for glass slats included with rail kits.

GLASS SLATS

Description	For 36" Rail Height	For 42" Rail Height
Glass Slats for Level Kits – Box of 9 – For Use with 6' Kits	73041331	73041332
Glass Slats for Level Kits – Box of 12 – For Use with 8' Kits	73041333	73041334

Glass slats are for residential use only.



Decorative Screen Panel Infill



4 1/8" Glass Slats

TOP RAILS

Description	White	Matte Black	Matte Bronze
6' Top Rail – Pellinore	73020442	73020448	73019456
8' Top Rail – Pellinore	73020443	73020449	73019462
6' Top Rail – Tristan	73020446	73020452	73019457
8' Top Rail – Tristan	73020447	73020453	73019463
6' Top Rail – Oberon*	73032049	73032042	73032048
8' Top Rail – Oberon*	73032052	73032050	73032051

Top Rails include 2 matching end covers.

*Oberon top rail is intended for level applications only. Deck board must be installed on top of Oberon profile.



Pellinore™



Tristan™

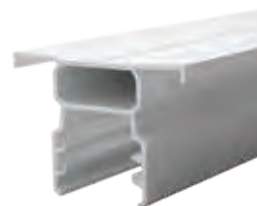

Oberon™*

BRACKETS

Description	White	Matte Black	Matte Bronze
Pellinore Level Bracket Kit (set of 4 – 2 top, 2 bottom)	73019301	73019298	73019490
Pellinore Stair Bracket Kit (set of 4 – 2 top, 2 bottom)	73019310	73019307	73019491
Pellinore Fixed Angle Stair Bracket (set of 4 – 2 top, 2 bottom)	73045480	73045479	73045481
Pellinore Angle Bracket Kit (set of 4 – 2 top, 2 bottom)	73019318	73019319	73019489
Tristan Level Bracket Kit (set of 4 – 2 top, 2 bottom)	73019300	73019297	73019496
Tristan Stair Bracket Kit (set of 4 – 2 top, 2 bottom)	73019309	73019306	73019497
Tristan Fixed Angle Stair Bracket (set of 4 – 2 top, 2 bottom)	73045483	73045482	73045484
Tristan Angle Bracket Kit (set of 4 – 2 top, 2 bottom)	73019315	73019316	73019495
Oberon Level Bracket Kit (set of 4 – 2 top, 2 bottom)	73040784	73040785	73040786



Level Brackets



Level Angle Brackets



Stair Brackets (0 to 38°)



Fixed Angle Stair Brackets (29 to 35°)

Brackets shown with Pellinore top rail and top rail end cover. Fixed angle stair brackets not available for Oberon.

Typical new stair construction utilizes a 7" rise and an 11" run which results in a 32° stair angle.

ACCESSORIES

Description	
NEW! BracketPro™ Installation Jig – for use with 2½" and 4¼" posts	73053555

Easily locates holes on posts to install brackets and provides level railing without having to measure or center brackets manually. For use with 2", 2½" and 4¼" posts.

NEW!



BracketPro



2-TO-3 RAIL BRACKETS

Description	White	Matte Black	Matte Bronze
2-to-3 Rail Bracket Kit (set of 4 – 2 top, 2 bottom)	73050446	73050444	73050445
2-to-3 Rail Angle Bracket Kit (set of 4 – 2 top, 2 bottom)	73050449	73050447	73050448



2-to-3 Rail Bracket Kit



2-to-3 Rail Angle Bracket Kit

OVER-THE-TOP BRACKETS

Description	White	Matte Black	Matte Bronze
Pellinore 2" Over-the-Top Post Bracket – Mid Post	73020663	73020681	73019487
Pellinore 2" Over-the-Top Post Bracket – Corner Post	73020664	73020682	73019486
Pellinore 2" Over-the-Top Post Bracket – End Post	73020665	73020683	73019488
Tristan 2" Over-the-Top Post Bracket – Mid Post	73020666	73020684	73019494
Tristan 2" Over-the-Top Post Bracket – Corner Post	73020667	73020685	73019492
Tristan 2" Over-the-Top Post Bracket – End Post	73020668	73020686	73019493
Oberon 2" Over-the-Top Post Bracket – Mid Post*	73040798	73040797	73040799
Oberon 2" Over-the-Top Post Bracket – Corner Post*	73040801	73040800	73040802
Oberon 2" Over-the-Top Post Bracket – End Post	73040788	73040787	73040796

*Does not include bracket covers; deck board will install over the top of Oberon top rail.



Mid Bracket



Corner Bracket

Style shown for use with Pellinore Top Rail



End Bracket

FASCIA BRACKET KITS

Description	White	Matte Black	Matte Bronze
Fascia Mount Mid Bracket Kit	73045489	73045488	73045490
Fascia Mount Outside Corner Bracket Kit	73045492	73045491	73045493
Fascia Mount Insider Corner Bracket Kit	73045495	73045494	73045496
Fascia Mount Juliette Bracket Kit	73045498	73045497	73045499
Fascia Mount Juliette Spacer*	73050297		

*Only necessary when Juliette application is using a fascia mid bracket and post.



Mid Bracket Kit



Outside Corner Bracket Kit



Inside Corner Bracket Kit



Juliette Bracket Kit



Fascia Mount Juliette Spacer

GATE KITS			
Description	White	Matte Black	Matte Bronze
36" Gate Kit	73020655	73020654	73019478
42" Gate Kit	73020658	73020657	73019479

Gate Kits include uprights, cross braces and gate kit hardware (2 hinges, 1 gravity latch – black only). Complete gate by purchasing rail panel and top rail separately. Gate kits cannot be used with Avalon glass or cable rail and cannot exceed widths of 48".



Gate Kit

TOUCH-UP PAINT			
Description	White	Matte Black	Matte Bronze
Touch-Up Paint Aerosol (12 oz)	73022328	73044481	73044482
Touch-Up Paint Pen (1/2 fl oz)	73022351	N/A	N/A
Touch-Up Paint Bottle & Brush (1/2 fl oz)	N/A	73044483	73044484

LED lighting options are available for use with Avalon Aluminum Railing. For details and options, see page 84.



METALWORKS EXCALIBUR®

MetalWorks Excalibur Steel Railing combines strength with a traditional and timeless style. Factory welded, fully assembled panels with hidden attachments and pre-attached brackets, allow for easy installation. Available in a traditional two rail design or in three decorative styles with textured matte black and hammered bronze finishes.



PRODUCT BENEFITS

- Panels with square balusters are factory welded — no assembly required
- Pre-attached brackets on posts make level installation easy and ensure consistent bottom spacing
- Code compliant

HOMEOWNER BENEFITS

- Decorative infill styles offer custom looks
- Premium powder coating provides maximum durability
- 15 Year Limited Warranty

DESIGN VERSATILITY

- Decorative panel designs complement Transform composite railing
- 4 infill options
- Available in 2 colors



Matte Black



Hammered Bronze



SOLARGUARD®

SolarGuard is a material composition that provides fade resistance* so that your outdoor living products will look good for years to come.

*Does not apply to white vinyl products.

Product Spotlight

MetalWorks Latitudes — with its unique horizontal rod design — provides homeowners with open views and modern styling.

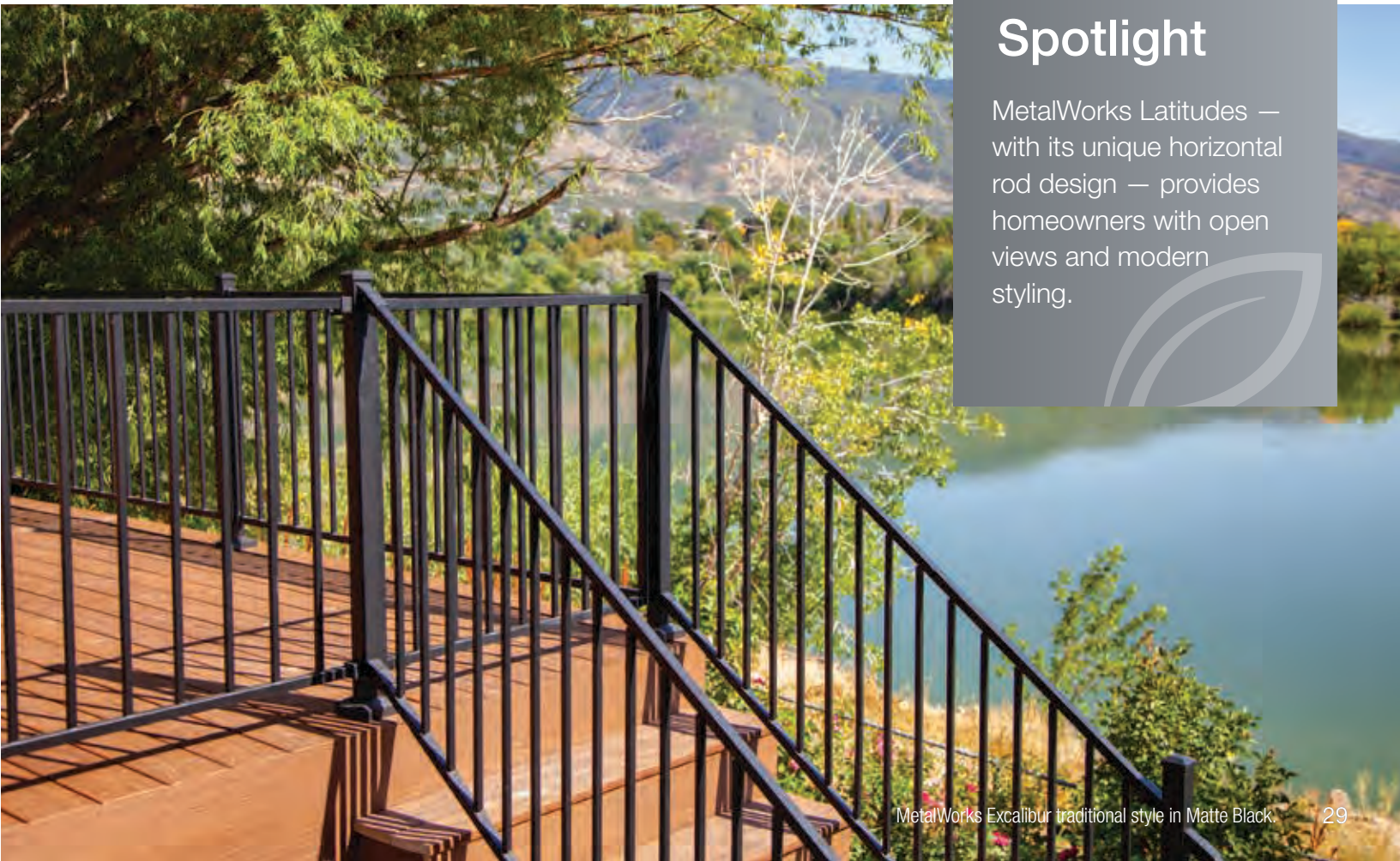

HOW TO SHOP:

TRADITIONAL RAIL PANEL

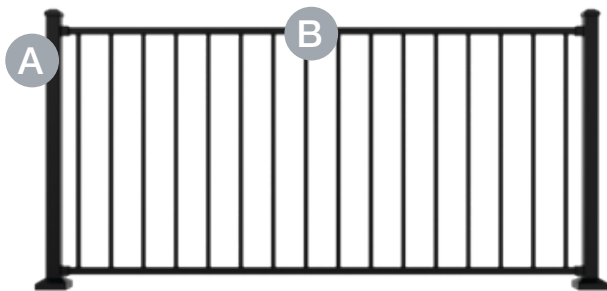

- A** Bracketed posts available as end, mid and corner for 36" or 42" finished heights; includes welded base plates, pre-mounted post caps and two-piece trim ring. Blank posts (brackets sold separately) available for stair application and include welded base plates, pre-mounted post caps, and two-piece trim ring. Fascia posts available (brackets sold separately) and include pre-mounted post cap.
- B** Factory welded, fully assembled rail panel available for both stair and level applications in 36" and 42" finished heights.

DECORATIVE PANELS (LEVEL ONLY)

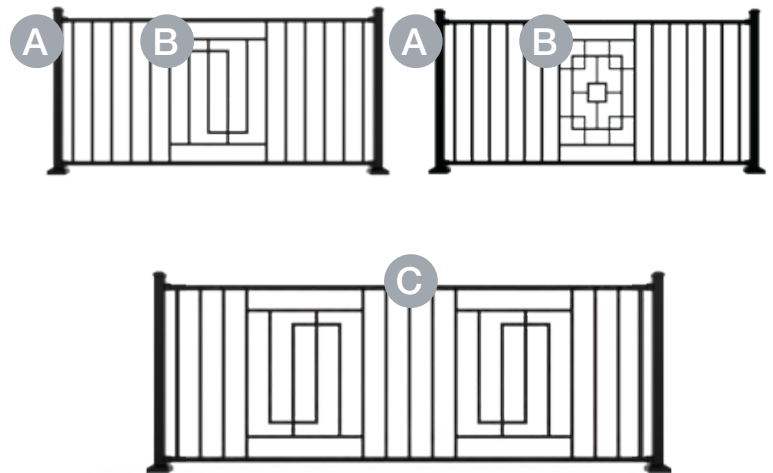

- A** Bracketed posts available as end, mid and corner for 36" or 42" finished heights; includes welded base plates, pre-mounted post caps and two-piece trim ring. Blank posts (brackets sold separately) available for stair application and include welded base plates, pre-mounted post caps, and two-piece trim ring. Fascia posts available (brackets sold separately) and include pre-mounted post cap.
- B** Factory welded, fully assembled rail panel available for both stair and level applications in 36" and 42" finished heights.
- C** Note: 8' wide versions differ for each style (Serpentine 8' style shown above).

LATITUDES HORIZONTAL RAIL PANEL

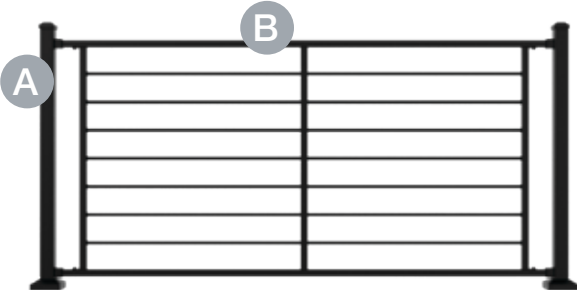

- A** Bracketed posts available as end, mid and corner for 36" or 42" finished heights; includes welded base plates, pre-mounted post caps and two-piece trim ring. Blank posts (brackets sold separately) available for stair application and include welded base plates, pre-mounted post caps, and two-piece trim ring. Fascia posts available (brackets sold separately) and include pre-mounted post cap.

- B** Factory welded, fully assembled rail panel available for both stair and level applications in 36" and 42" finished heights.

2" X 2" POSTS		
Description	Matte Black	Hammered Bronze
2" x 2" x 38" Mid Post Assembly for 36" Rail Height with 2" Bottom Space	73018345	73018346
2" x 2" x 38" End Post Assembly for 36" Rail Height with 2" Bottom Space	73018336	73018337
2" x 2" x 38" Corner Post Assembly for 36" Rail Height with 2" Bottom Space	73018326	73018327
2" x 2" x 44" Mid Post Assembly for 42" Rail Height with 2" Bottom Space	73018349	73018350
2" x 2" x 44" End Post Assembly for 42" Rail Height with 2" Bottom Space	73018339	73018340
2" x 2" x 44" Corner Post Assembly for 42" Rail Height with 2" Bottom Space	73018330	73018331
2" x 2" x 40" Mid Post Assembly for 38" Rail Height with 4" Bottom Space	73018347	73018348
2" x 2" x 40" End Post Assembly for 38" Rail Height with 4" Bottom Space	73018021	73018338
2" x 2" x 40" Corner Post Assembly for 38" Rail Height with 4" Bottom Space	73018023	73018328
2" x 2" x 38" Blank Post for 36" Rail Height (Brackets sold separately)	73018315	73018316
2" x 2" x 40" Blank Post for 38" Rail Height (Brackets sold separately)	73018317	73018022
2" x 2" x 44" Blank Post for 42" Rail Height (Brackets sold separately)	73018318	73018319
2" x 2" x 46" Blank Post for 44" Rail Height (Brackets sold separately)	73018320	73018321
2" x 2" x 48" Blank Post (Brackets sold separately)	73018322	73018323
2" x 2" x 52" Fascia Mount Post (Fascia brackets sold separately)	73019191	73019192

Posts include welded base plate, pre-mounted post top, bracket covers, two-piece trim ring and shims.
 You may need to purchase a longer blank post for stair application depending on your installation scenario.

3" X 3" POSTS		
Description	Matte Black	Hammered Bronze
3" x 3" x 38" Mid Post Assembly for 36" Rail Height with 2" Bottom Space	73044021	73044027
3" x 3" x 38" End Post Assembly for 36" Rail Height with 2" Bottom Space	73044020	73044026
3" x 3" x 38" Corner Post Assembly for 36" Rail Height with 2" Bottom Space	73044022	73044028
3" x 3" x 40" Mid Post Assembly for 38" Rail Height with 4" Bottom Space	73044024	73044030
3" x 3" x 40" End Post Assembly for 38" Rail Height with 4" Bottom Space	73044023	73044029
3" x 3" x 40" Corner Post Assembly for 38" Height Rail with 4" Bottom Space	73044025	73044031
3" x 3" x 40" Blank Post for 36" to 38" Rail Height (Brackets sold separately)	73032020	73032021
3" x 3" x 46" Blank Post for 36" to 44" Rail Height (Brackets sold separately)	73032022	73032023

Posts include welded base plate, pre-mounted post top, bracket covers, two-piece trim ring and shims.
 You may need to purchase a longer blank post for stair application depending on your installation scenario.

2" X 2" POSTS POSTS – CALIFORNIA ONLY*		
Description	Matte Black	Hammered Bronze
2" x 2" x 44" Mid Post Assembly for 42" Rail Height with 4" Bottom Space	73018046	73018047
2" x 2" x 44" End Post Assembly for 42" Rail Height with 4" Bottom Space	73018044	73018045
2" x 2" x 44" Corner Post Assembly for 42" Height Rail with 4" Bottom Space	73018043	73018329

Posts include welded base plate, pre-mounted post top, bracket covers, two-piece trim ring and shims.

* These SKUs are CA code compliant and only stocked in our West Coast warehouse. They are for distribution in CA only.



Mid Post



Corner Post



End Post



Blank Post



Fascia Post



Fascia Post shown with brackets

TRADITIONAL RAIL PANELS

Description	Matte Black	Hammered Bronze
6' x 34" Level Rail Panel – Square Baluster	73018004	73018298
8' x 34" Level Rail Panel – Square Baluster	73018024	73018016
10' x 34" Level Rail Panel – Square Baluster*	73018015	73018291
6' x 34" Stair Rail Panel – Square Baluster	73018019	73018304
8' x 34" Stair Rail Panel – Square Baluster	73018310	73018311
6' x 40" Level Rail Panel – Square Baluster	73018299	73018300
8' x 40" Level Rail Panel – Square Baluster	73018018	73018303
8' x 40" Stair Rail Panel – Square Baluster	73018020	73018314

34" panels can be installed at a finished rail height of 36" with 2" bottom space or 38" with 4" bottom space. 40" panels can be installed at a finished rail height of 42" with 2" bottom space or 44" with 4" bottom space.

*10' panels can be used to cut down to shorter lengths or for long spans where code compliance is not required.

TRADITIONAL RAIL PANELS – CALIFORNIA ONLY*

Description	Matte Black	Hammered Bronze
6' x 38¼" Level Rail Panel – Square Baluster	73018030	73018031
8' x 38¼" Level Rail Panel – Square Baluster	73018032	73018033
6' x 32¼" Stair Rail Panel – Square Baluster	73018034	73018035
8' x 32¼" Stair Rail Panel – Square Baluster	73018036	73018309

* These SKUs are CA code compliant and only stocked in our West Coast warehouse. They are for distribution in CA only.

SERPENTINE RAIL PANELS

Description	Matte Black	Hammered Bronze
6' x 34" Serpentine Level Rail Panel – Square Baluster with Design	73045160	73045168
8' x 34" Serpentine Level Rail Panel – Square Baluster with Design	73045161	73045169
6' x 40" Serpentine Level Rail Panel – Square Baluster with Design	73045162	73045170
8' x 40" Serpentine Level Rail Panel – Square Baluster with Design	73045163	73045171

MOSAIC RAIL PANELS

Description	Matte Black	Hammered Bronze
6' x 34" Mosaic Level Rail Panel – Square Baluster with Design	73045156	73045164
8' x 34" Mosaic Level Rail Panel – Square Baluster with Design	73045157	73045165
6' x 40" Mosaic Level Rail Panel – Square Baluster with Design	73045158	73045166
8' x 40" Mosaic Level Rail Panel – Square Baluster with Design	73045159	73045167



Traditional

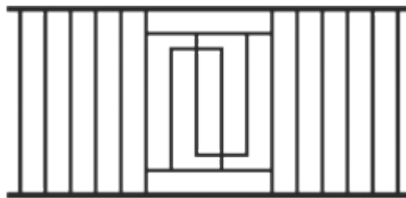

Serpentine

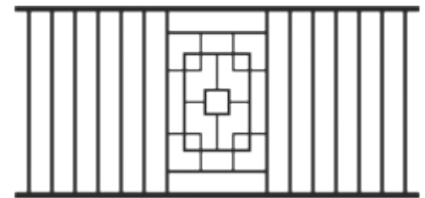

Mosaic

LATITUDES RAIL PANELS		
Description	Matte Black	Hammered Bronze
6' x 34" Latitudes Level Rail Panel – Horizontal Round Rails	73044057	N/A
8' x 34" Latitudes Level Rail Panel – Horizontal Round Rails	73044089	N/A
6' x 34" Latitudes Stair Rail Panel – Horizontal Round Rails	73044087	N/A
6' x 40" Latitudes Level Rail Panel – Horizontal Round Rails	73044058	N/A
8' x 40" Latitudes Level Rail Panel – Horizontal Round Rails	73044086	N/A
6' x 40" Latitudes Stair Rail Panel – Horizontal Round Rails	73044088	N/A

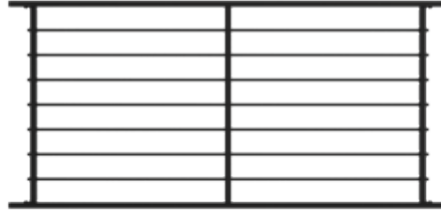

Latitudes

BRACKETS		
Description	Matte Black	Hammered Bronze
Bracket Kit for Level Rail	73018013	73018025
Bracket Kit for Stair or Level Angle Rail	73018014	73018026
Imperial Decorative Bracket for Level Rail*	73044946	73044947
Scrollwork Decorative Bracket for Level Rail*	73044948	73044949
Fascia Post Bracket Kit – For 2" Posts Only (mounting hardware not included)	73019193	73019194

* Decorative brackets come with hardware to attach to either wooden posts or steel posts.



Level Brackets



Stair/Angle Brackets



Imperial Brackets



Scrollwork Brackets



Fascia Brackets

ACCESSORIES

Description	Matte Black	Hammered Bronze
Top Cap Flush Bracket Kit (set of 4)	73018886	73018887
Rail Cutting Jig	73018283	



Flush Mount Bracket

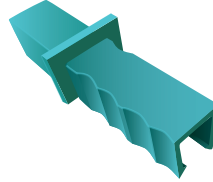

Rail Cutting Jig



GATES

Description	Matte Black	Hammered Bronze
34" x 36" Gate, Assembled for 36"– 38" Rail – 36" Finished Opening	73018268	N/A
Gate Ends for 36"– 38¼" Rail – Custom Width – Rail Panel Sold Separately	73018276	73018277
Gate Ends for 42" Rail – Custom Width – Rail Panel Sold Separately (CA only)	73018278	73018279
Gate Ends for 42"– 44" Rail – Custom Width – Rail Panel Sold Separately	73018280	73018281
Compact Butterfly Hinge Kit Pair (Black aluminum)	73024441	
Gravity Latch (Black steel)	73024440	



Pre-Assembled Gate



Gate Ends

TOUCH-UP PAINT

Description	Matte Black
Touch-Up Paint Aerosol (12 oz)	73044481
Touch-Up Paint Bottle & Brush (½ fl oz)	73044483

Cut rail ends may be painted with any zinc-rich primer or paint. For Matte Black touch-ups, touch-up paint or Rust-Oleum® Satin Canyon Black, color code 249844 is recommended. For Hammered Bronze touch-ups, we recommend Rust-Oleum® Hammered Brown, color code 210880*.

*Rust-Oleum® is a registered trademark of Rust-Oleum Brand Company.

TRANSFORM®

Transform Composite Railing has the look and feel of a wood railing, but provides superior resistance to moisture, mold and warping. Made with Compositore® — a material that contains no wood or organic fibers — Transform features a lightly textured, durable finish. Available with multiple top rail options and infill styles, including traditional square balusters, black round aluminum balusters and cable. For a more unique product, you can mix and match Avalon Aluminum Railing or MetalWorks Excalibur Steel Railing with Transform posts and top rails to easily create a custom fabricated look that doesn't require custom work.



PRODUCT BENEFITS

- Square and round aluminum balusters securely fit into rails without using screws
- Cable infill option attaches easily to posts
- Universal bracket for level, stair and angled applications
- Code compliant
- Made in the USA

HOMEOWNER BENEFITS

- Does not warp, splinter or rot
- Easy to maintain
- Long lasting color retention
- Transferrable Limited Lifetime Warranty

DESIGN VERSATILITY

- Hidden brackets provide a clean, finished look
- Mix and match with aluminum or steel railing for a custom look
- 4 top rail options and 3 infill options
- Available in 4 colors



COMPOSICORE®

Compositore used in our railing products, contains no wood fibers, making it water resistant meaning it will not rot, splinter, warp or stain and is resistant to mold — keeping your railing beautiful for years to come.



SOLARGUARD®

SolarGuard is a material composition that provides fade resistance* so that your outdoor living products will look good for years to come.

*Does not apply to white vinyl products.



HOW TO SHOP:

FULL RAIL KITS (SATIN WHITE ONLY)

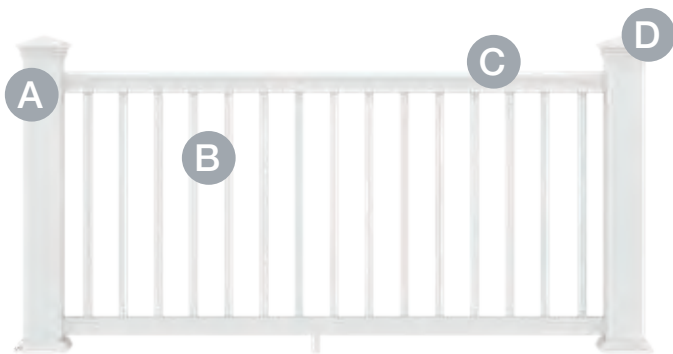

BEAM AND BALUSTER KITS

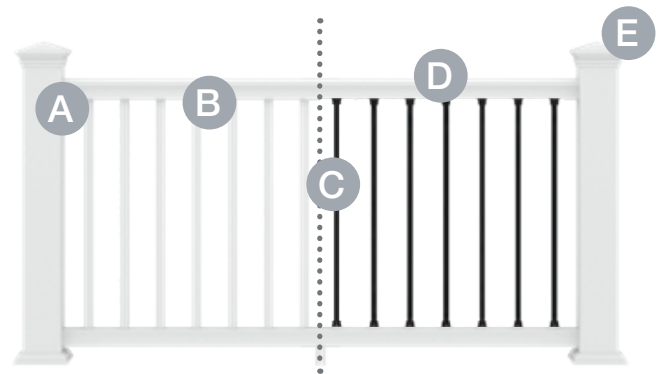

- A** Post sleeve for wooden 4" x 4" or structural posts.
- B** Rail Kit – includes top and bottom beams, bottom rail, brackets, square balusters and support foot. Satin White only.
- C** Top rail – choose from 4 styles.
- D** Post accessories include post caps in both standard and LED styles and trim rings.

- A** Post sleeve for wooden 4" x 4" or structural posts.
- B** Beam Kit – includes top and bottom beams, bottom rail, brackets and support foot.
- C** Balusters – choose from square or black round aluminum. Square balusters include baluster plugs; baluster shoes for black round aluminum sold separately.
- D** Top rail – choose from 4 styles.
- E** Post accessories include post caps in both standard and LED styles and trim rings.

CABLE RAIL INFILL

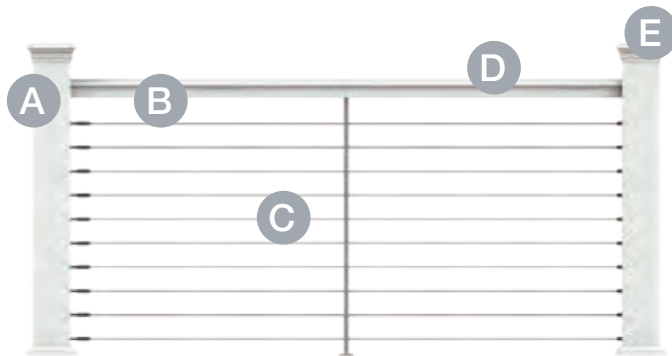

- A** Post sleeve and wooden 4" x 4" posts required for cable install.
- B** Cable Beam Kit – includes top and bottom beams, bottom rail, brackets and mid baluster support. Bottom rail is optional for installation.
- C** Cable fittings (10 for a 36" finished height, 12 for a 42" finished height, and cable wire (100' spool or 500' spool).
- D** Top rail – choose from 4 styles.
- E** Post accessories include post caps in both standard and LED styles and trim rings.

MIX AND MATCH

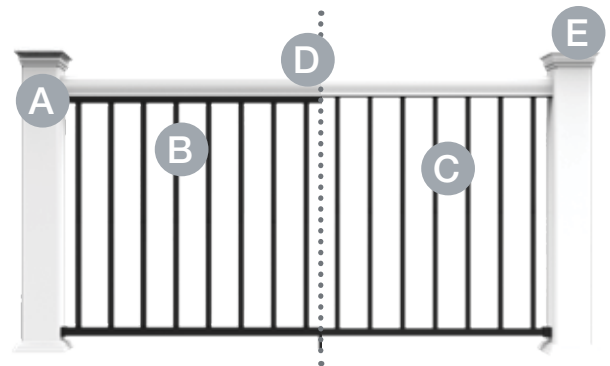

- A** Post sleeve for wooden 4" x 4" or structural posts.
- B** Avalon Aluminum Railing with Tristan top rail allows for a Transform top rail to be installed on top.
- C** For MetalWorks Excalibur, a top rail adapter is available to install a Transform top rail on an Excalibur panel.
- D** Top rail – choose from 4 styles.
- E** Post accessories include post caps in both standard and LED styles and trim rings.

STRUCTURAL POSTS		
Description	Flush Mount	Fascia Mount
Structural Post for 36" Railing Height	73019022	73019023
Structural Post for 42" Railing Height	73019024	73019025
5" x 5" Post Inserts*	73019139	

POST SLEEVES				
Description	Satin White	Caramel	Wheat	Ironstone
5" x 5" x 39" Post Sleeve – Boxed	73014245	73019143	73019142	73019141
5" x 5" x 54" Post Sleeve – Boxed	73014244	73014637	73019079	73014638
5" x 5" x 120" Post Sleeve – Boxed	73014246	N/A	N/A	N/A



Structural Post –
Flush Mount

Structural Post –
Thru/Fascia Mount



Post Insert



Post Sleeve

*Post sleeves come with two 5" x 5" post inserts; more can be purchased for use when sleeving 4" x 4" wooden posts with the 120" post sleeve cut to size.

POST CAPS & TRIM RINGS				
Description	Satin White	Caramel	Wheat	Ironstone
5" x 5" Pinnacle Post Cap	73019127	73019130	73019129	73019128
5" x 5" Pinnacle LED Post Cap (0.80W)	73019361	73019364	73019363	73019362
5" x 5" Zenith Post Cap	73004495	73004492	73004494	73004493
5" x 5" Zenith LED Post Cap (0.80W)	73019365	73019368	73019367	73019366
5" x 5" Trim Ring	73019038	73014643	73019040	73019039



Pinnacle Post Cap



Pinnacle LED
Post Cap



Zenith Post Cap

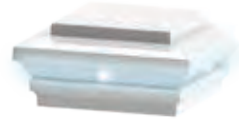

Zenith LED
Post Cap



Trim Ring

RAIL KITS

DESCRIPTION	Satin White
6' x 36" Level Rail Kit with Square Balusters	73019032
8' x 36" Level Rail Kit with Square Balusters	73019033
6' x 42" Level Rail Kit with Square Balusters	73019035
8' x 42" Level Rail Kit with Square Balusters	73019036
6' x 36" Stair Rail Kit with Square Balusters	73019034
6' x 42" Stair Rail Kit with Square Balusters	73019037

Rail kits include balusters, top and bottom beams, bottom rail, brackets, support foot and hardware. Top rail sold separately.

BEAM KITS – FOR LEVEL OR STAIR

Description	Satin White	Caramel	Wheat	Ironstone
6' Beam Kit for Square or Round Balusters	73019061	73019063	73019065	73019067
8' Beam Kit for Square or Round Balusters	73019062	73019064	73019066	73019068
6' Beam Kit for Cable Rail	73019347	73019353	73019349	73019351
8' Beam Kit for Cable Rail	73019348	73019354	73019350	73019352

Cable rail must be installed using a 4" x 4" wooden post to support the cable tension. Bottom rail included in beam kits, but optional for cable installation.

Beam kits include top and bottom beams, bottom rail, brackets, support foot, mid-baluster support (cable rail kits only) and hardware. Top rail and balusters sold separately.



1 1/8" Square Balusters



3/4" Black Round Aluminum Balusters



1/8" Cable Rail Infill

1 1/8" SQUARE BALUSTERS

Description	Satin White	Caramel	Wheat	Ironstone
36" Square Baluster – Level – 10 Pack	73019045	73019049	73019053	73019057
42" Square Baluster – Level – 10 Pack	73019046	N/A	N/A	N/A
36" Square Baluster – Stair (32°) – 10 Pack	73019047	73019051	73019055	73019059
42" Square Baluster – Stair (32°) – 10 Pack	73019048	N/A	N/A	N/A

15 balusters needed for a 6' kit, 20 balusters needed for an 8' kit.

3/4" ROUND ALUMINUM BALUSTERS & ACCESSORIES	
Description	Black
36" Round Aluminum Baluster – 10 Pack	73019041
42" Round Aluminum Baluster – 10 Pack	73019042
Aluminum Baluster Shoes – Level – (box of 20 for 10 balusters)	73019043
Aluminum Baluster Shoes – Stair – (box of 20 for 10 balusters – for angles from 32° to 38°)	73019044

15 balusters needed for a 6' kit, 20 balusters needed for an 8' kit.

CABLE RAIL INFILL & ACCESSORIES		
Description	Level	Stair
Cable Fitting for 36" Finished Height Installation – Box of 20 (10 sets of fittings)	73019357	73019358
Cable Fitting for 42" Finished Height Installation – Box of 24 (12 sets of fittings)	73019359	73019399
Cable Wire – 100' Length Spool	73019360	
Cable Wire – 500' Length Spool	73019381	
Cable Release Key	73025484	
E-Z Clean Cable Cleaner and Protectant	73040274	

Cable Rail must be installed using a 4" x 4" wooden post to support the cable tension. Bottom rail included in beam kits, but optional for cable installation.

TOP RAILS				
Description	Satin White	Caramel	Wheat	Ironstone
6' Transform Top Rail – Aspire	73019069	73019075	73019071	73019073
8' Transform Top Rail – Aspire	73019070	73019076	73019072	73019074
6' Transform Top Rail – Emerge	73019080	73019086	73019082	73019084
8' Transform Top Rail – Emerge	73019081	73019087	73019083	73019085
6' Transform Top Rail – Presence	73019088	73019094	73019090	73019092
8' Transform Top Rail – Presence	73019089	73019095	73019091	73019093
6' Transform Graspable Top Rail – For Stairs	73019009	73019012	73019010	73019011



Presence®



Emerge®

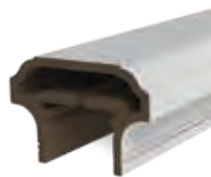

Aspire®



Graspable Stair

For 45° angle railing, the Emerge top rail can be cut at 45° and installed. If using the Presence or Aspire top rail, the two adjacent rail sections must be cut at 22.5° and installed on posts mounted at 22.5°. Please contact our customer service department at 1-877-265-2220 for more information.

GATE KITS

Description	Satin White
36" Gate Kit	73019237
42" Gate Kit	73019241



Gate kits include 2 uprights, 2 white cross braces, black Barrette Outdoor Living hardware (2 hinges, 1 latch). Rail section and top rail sold separately. Gates cannot exceed 48" in opening width.

LIGHTING ACCESSORIES

Description	Satin White	Caramel	Wheat	Ironstone
5" x 5" Pinnacle LED Post Cap (0.80W)	73019361	73019364	73019363	73019362
5" x 5" Zenith LED Post Cap (0.80W)	73019365	73019368	73019367	73019366
Dome Light (0.80W) – SATIN WHITE	73019407			
Stair/Side Light (0.40W) – SATIN WHITE	73019414			
Flush Deck Light (0.40W)	73019403			
LED Under-Rail Lighting (92" strip – 3W)	73019376			
Bluetooth Transformer for LED Lighting	73041277			
Electrical Wire for LED Lighting – 2'	73032449			
Electrical Wire for LED Lighting – 5'	73019375			
Electrical Wire for LED Lighting – 7'	73019373			
Electrical Wire for LED Lighting – 9'	73019374			
2-Way Splitter	73019370			
5-Way Splitter	73019371			

Transformer is 50W and can be used with lighted post caps or under-rail lighting. Includes photocell, built-in dimmer, timer, remote and is Bluetooth capable. Download the "SmartPower50" app from the App Store or Google Play to control your lighting via your smartphone.



EXTRA ACCESSORIES

Description	
Transform Brackets – Set of 4	73019126
Transform Baluster Plugs for 1 1/8" Square Balusters – Bag of 20	73019232
96" Aspire/Presence Top Rail IBC Stiffener – Box of 4*	73019002
96" Emerge Top Rail IBC Stiffener – Box of 4*	73019003
72" Transform Top Rail Adapter for mix and match with MetalWorks Excalibur® (2 and hardware)	73019235
96" Transform Top Rail Adapter for mix and match with MetalWorks Excalibur® (2 and hardware)	73019236

*For commercial railing heights of 42" with lengths over 91", the IBC Stiffener is required for code compliance.

ENDURANCE® ORIGINAL RAIL™

Endurance Original Rail is a full vinyl railing system with everything needed to build a railing in one box. Endurance Original Rail offers dependable function with rails that are reinforced with aluminum stiffeners for added strength. A wide range of brackets are also available to meet a variety of installation needs.



PRODUCT BENEFITS

- Aluminum stiffeners reinforce top and bottom rails for added strength and support
- Wide range of brackets available to meet variety of installation needs
- Code compliant
- Made in the USA

HOMEOWNER BENEFITS

- Easy to maintain
- Transferrable Limited Lifetime Warranty

DESIGN VERSATILITY

- Hidden fasteners provide a clean, finished look
- 4 infill options
- Available in 3 colors



SOLARGUARD®

SolarGuard is a material composition that provides fade resistance* so that your outdoor living products will look good for years to come.

*Does not apply to white vinyl products.



HOW TO SHOP:

SQUARE BALUSTERS

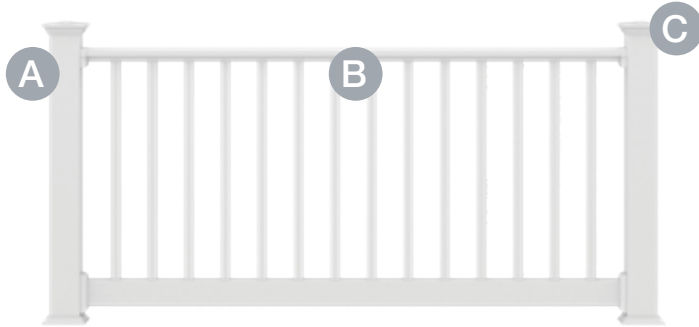

- A** Post sleeves available for wooden 4" x 4" or structural posts.
- B** Rail Kit includes top and bottom rails with aluminum stiffeners, balusters, brackets and mounting hardware.
- C** Post caps and LED post caps as well as a variety of trim rings available.

BLACK ROUND ALUMINUM BALUSTERS

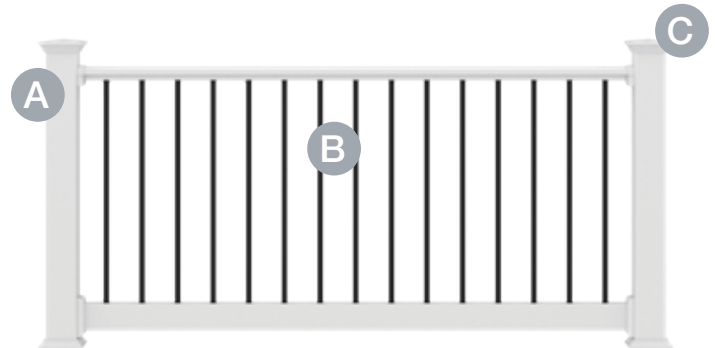

- A** Post sleeves available for wooden 4" x 4" or structural posts.
- B** Rail Kit includes top and bottom rails with aluminum stiffeners, balusters, brackets and mounting hardware.
- C** Post caps and LED post caps as well as a variety of trim rings available.

TURNED BALUSTERS

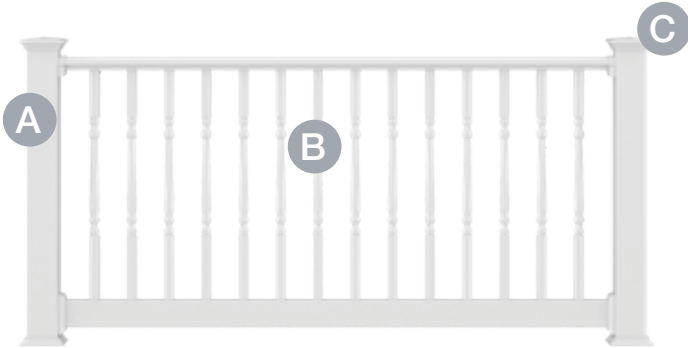

- A** Post sleeves available for wooden 4" x 4" or structural posts.
- B** Rail Kit includes top and bottom rails with aluminum stiffeners, balusters, brackets and mounting hardware.
- C** Post caps and LED post caps as well as a variety of trim rings available.

GLASS SLATS (LEVEL ONLY)

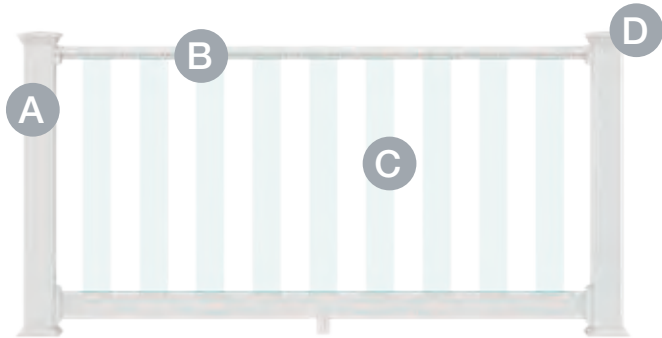

- A** Post sleeves available for wooden 4" x 4" or structural posts.
- B** Rail Kit contains top and bottom rails with aluminum stiffeners, brackets and mounting hardware.
- C** Glass slats sold separately for 36" and 42" level sections only.
- D** Post caps and LED post caps as well as a variety of trim rings available.

STRUCTURAL POSTS

Description	
Structural Post for 36" Rail Height – Flush Mount	73019022
Structural Post for 36" Rail Height – Thru/Fascia Mount	73019023
Structural Post for 42" Rail Height – Flush Mount	73019024
Structural Post for 42" Rail Height – Thru/Fascia Mount	73019025

VINYL POST SLEEVES & POST WRAPS

Description	White	Clay	Sand
4" x 4" x 39" Post Sleeve (unit pack of 84)	61109087	73053601	73041475
4" x 4" x 39" Post Sleeve (unit pack of 22)	73019260	N/A	N/A
4" x 4" x 45" Post Sleeve	61109088	73053602	73041476
4" x 4" x 54" Post Sleeve	73019029	N/A	N/A
4" x 4" x 100" Post Sleeve	73012479	N/A	N/A
4" x 4" x 108" Post Sleeve	61109090	73053603	73041477
4" x 4" x 120" Post Sleeve	73006803	N/A	N/A
4" x 4" x 48" Turned Post Sleeve (requires structural post)	73018760	N/A	N/A
5" x 5" x 39" Post Sleeve	73043921	N/A	N/A
5" x 5" x 45" Post Sleeve	73043922	N/A	N/A
5" x 5" x 108" Post Sleeve	73043923	N/A	N/A
5" x 5" Post Inserts*	73019139		
6" x 6" x 54" Post Sleeve	73018734	N/A	N/A
6" x 6" x 108" Post Sleeve	73018731	73053608	73041478
6" x 6" x 144" Post Sleeve	73047640	N/A	N/A
4" x 4" x 96" – 4 Piece Post Wrap**	73018473	73053604	73041479
4" x 4" x 120" – 4 Piece Post Wrap**	73018007	73053605	73041480
6" x 6" x 96" – 4 Piece Post wrap**	73018478	73053606	73041481
6" x 6" x 120" – 4 Piece Post Wrap**	73018008	73053607	73041482

*Post Inserts are used when sleeving 4" x 4" wooden posts or structural posts.

**4" x 4" Post Wrap can wrap a post from 3³/₈" square to 4¹/₈" square and 6" x 6" Post Wrap can wrap a post from 5⁷/₁₆" square to 6¹/₈" square.



Structural Post –
Flush Mount



Structural Post –
Thru/Fascia Mount



Post Sleeve



Post Insert

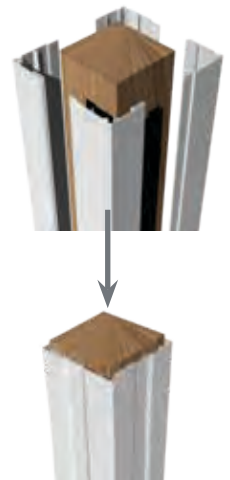

4-Piece Post Wrap

VINYL PORCH POSTS			
Description	White	Clay	Sand
4" x 4" x 108" Square Post – 2,500 lb. Capacity*	73018767	N/A	N/A
4" x 4" x 108" Turned Post – 2,500 lb. Capacity*	73018752	N/A	N/A
5" x 5" x 108" Square Post – 5,000 lb. Capacity*	73018769	N/A	N/A
5" x 5" x 108" Turned Post – 5,000 lb. Capacity*	73018010	73053609	73041483
5" x 5" x 108" Premiere Square Post – 4,500 lb. Capacity**	73047642	N/A	N/A
5" x 5" x 108" Premiere Turned Post – 4,500 lb. Capacity**	73047641	N/A	N/A

*Porch Posts require a Porch Post Mounting Kit

**Premiere Posts include post mounting kits. Internal blocking not included and required if mounting railing to these posts.

PORCH POST MOUNTING KITS	
Description	
4" Standard Base Kit (includes 1 bottom and 1 top mounting plate)	73018005
4" Wind Uplift Base Kit* (includes 1 bottom, 1 top mounting plate, 2 pistons and 2 PVC gaskets)	73018089
5" Standard Base Kit (includes 1 bottom and 1 top mounting plate)	73018006
5" Wind Uplift Base Kit* (includes 1 bottom, 1 top mounting plate, 2 pistons and 2 PVC gaskets)	73018090

*Wind Uplift Base Kit prevents wind uplift up to 2,800 lbs.

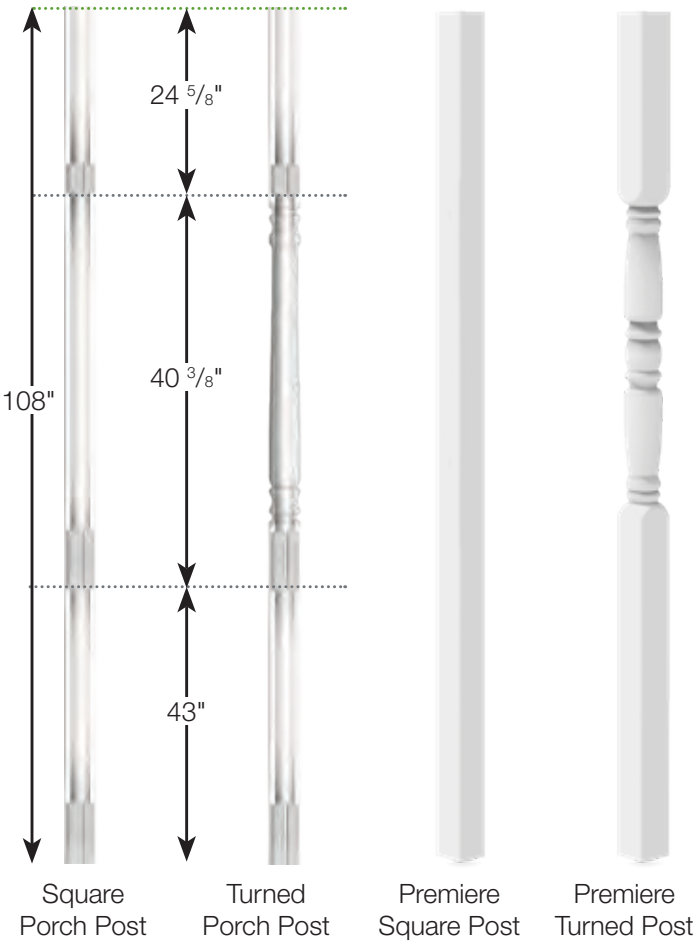

*The Wind Uplift Base Kit is shown in black for illustration purposes only. The PVC gasket prevents corrosion of the base plate and accommodates all base kits.

VINYL POST CAPS			
Description	White	Clay	Sand
4" x 4" Flat Post Cap	73018076	73053668	73041484
4" x 4" New England Post Cap	73044950	73053673	73044952
4" x 4" Elite Post Cap	73018073	73018071	73041485
4" x 4" Heritage Post Cap	73012500	N/A	N/A
4" x 4" Contemporary Post Cap	73019233	N/A	N/A
4" x 4" Contemporary Solar Post Cap	73019234	73045510	73045511
5" x 5" Flat Post Cap	73003093	N/A	N/A
5" x 5" New England Post Cap	73045003	N/A	N/A
5" x 5" Contemporary Post Cap	73013124	N/A	N/A
5" x 5" Contemporary Solar Post Cap	73013110	N/A	N/A
6" x 6" New England Post Cap	73018108	73018106	73041489
6" x 6" Elite Post Cap	73018105	N/A	N/A



Flat Post Cap

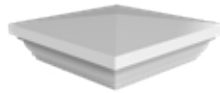

New England Post Cap



4" Elite Post Cap



6" Elite Post Cap



Heritage Post Cap



Contemporary Post Cap

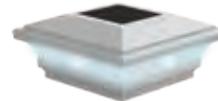

Contemporary Solar Post Cap

VINYL POST TRIM RINGS			
Description	White	Clay	Sand
4" x 4" Elite Trim Ring	73018091	73018092	73041490
4" x 4" Heritage Trim Ring*	73012503	73053674	73045024
4" x 4" Low Profile Trim Ring	73045041	73053680	73045043
5" x 5" 2-Piece Trim Ring	73043929	N/A	N/A
3.5" to 6.5" – 4-Piece Elite Trim Ring**	73018131	73018066	73041493

*The Heritage Trim Ring complements the New England Post Cap and the Heritage Post Cap. Does not allow for a 2" bottom space when used with Endurance Original Rail.

**Adjustable Elite 4-Piece Trim Ring can be installed at any time and can be adjusted to fit posts from 3½" x 3½" to 6½" x 6½" without nails, screws or glue. 4-Piece Elite Trim Ring required for Wind Uplift Base Kit.



Elite Trim Ring



Heritage Trim Ring



Low Profile Trim Ring



5" 2-Piece Trim Ring



4-Piece Elite Trim Ring

1 1/4" SQUARE BALUSTER KITS

Description	White	Clay	Sand
4' x 36" H – Level Rail Kit	73018509	N/A	N/A
6' x 36" H – Level Rail Kit	73018009	73053618	73041395
8' x 36" H – Level Rail Kit	73018000	73053619	73041396
10' x 36" H – Level Rail Kit	73018498	N/A	N/A
6' x 36" H – 32° to 38° Stair Rail Kit	73019104	73053624	73041397
8' x 36" H – 32° to 38° Stair Rail Kit	73019116	73053627	73041398
6' x 42" H – Level Rail Kit	73018705	73053622	73041399
8' x 42" H – Level Rail Kit	73018708	73053623	73041400
8' x 42" H – 32° to 38° Stair Rail Kit	73019125	73053629	73041402

Kits include top and bottom rails with aluminum stiffeners, balusters, bracket kit and installation hardware. Support foot required and sold separately for all installed rail lengths over 8'.

3/4" ROUND ALUMINUM BALUSTER KITS

Description	White	Clay	Sand
6' x 36" H – Level Rail Kit	73018553	73053620	73041404
8' x 36" H – Level Rail Kit	73018558	73053621	73041405
10' x 36" H – Level Rail Kit	73018547	N/A	N/A
6' x 36" H – 32° to 38° Stair Rail Kit	73019110	73053625	73041406
8' x 36" H – 32° to 38° Stair Rail Kit	73019122	73053628	73041407

Kits include top and bottom rails with aluminum stiffeners, balusters, bracket kit and installation hardware. Support foot required and sold separately for all installed rail lengths over 8'.

1 1/4" TURNED BALUSTER KITS

Description	White
6' x 36" H – Level Rail Kit – 1 1/4" Turned Baluster	73018633
8' x 36" H – Level Rail Kit – 1 1/4" Turned Baluster	73018636
10' x 36" H – Level Rail Kit – 1 1/4" Turned Baluster	73018626
6' x 36" H – 32° to 38° Stair Rail Kit – 1 1/4" Turned Baluster	73019107
8' x 36" H – 32° to 38° Stair Rail Kit – 1 1/4" Turned Baluster	73019119

Kits include top and bottom rails with aluminum stiffeners, balusters, bracket kit and installation hardware. Support foot required and sold separately for all installed rail lengths over 8'.



1 1/4" Square Balusters



3/4" Round Aluminum Balusters



1 1/4" Turned Balusters

GLASS SLAT RAIL KITS

Description	White
6' Level Rail Kit – for Glass Slats – Requires 9 Level Glass Slats	73018530
8' Level Rail Kit – for Glass Slats – Requires 12 Level Glass Slats	73018540

Kits include top and bottom rails with aluminum stiffeners, bracket kit, support foot and installation hardware. Glass slats sold separately.

GLASS SLATS

Description	36"	42"
Glass Slats for Level Kits – Box of 9 – For Use with 6' Kits	73041331	73041332
Glass Slats for Level Kits – Box of 12 – For Use with 8' Kits	73041333	73041334

42" glass slats for residential use only. Support foot required and included for glass railing sections 6' to 8'.



4 1/8" Glass Slats (Level only)

ACCESSORIES

Description	White	Clay	Sand
Level Mounting Bracket Kit – 2 Pairs	73019016	73019018	73041408
Stair Mounting Bracket Kit – 2 Pairs	73019017	73019019	73041409
0° to 44° Level Mounting Bracket Kit – 1 Pair	73018065	73018017	73041411
45° Level Mounting Bracket Kit – 1 Pair	73018086	73018084	73041412
Round Column Mounting Bracket Kit – 1 Pair	73018115	73018113	73041410
Paintable Round Column Mounting Bracket Adapter Kit – 1 Pair	73018116	N/A	N/A
2" to 4" Level Rail Support Kit	73018129	73018127	73041494

Level rail support required for lengths over 8' (10' panels being used at any lengths longer than 8'). Endurance Original Rail kits (except glass kits) do not include a support foot.



Level Mounting Bracket Kit



Stair Mounting Bracket Kit



0° to 44° Level Bracket Kit*



45° Mounting Bracket Kit



Round Column Mounting Bracket Kit For 8" Columns



Paintable Round Column Bracket Adapter Kit for 8" Columns

VINYL RAIL GATE KITS

Description	White	Clay	Sand
Standard Width Gate Kit – 36" H – 1¼" Square Balusters	73018135	N/A	N/A
Custom Width Gate Kit – 36" H – 1¼" Square Balusters	73045025	73053675	73045027
Custom Width Gate Kit – 36" H – 1½" Square Balusters	73045028	73053676	73045030
Custom Width Gate Kit – 36" H – 1¼" Turned Balusters	73045034	N/A	N/A
Custom Width Gate Kit – 36" H – 1½" Turned Balusters	73045044	73053681	73045046
Custom Width Gate Kit – 36" H – ¾" Round Aluminum Balusters	73045031	73053677	73045033
Custom Width Gate Kit – 42" H – 1¼" Square Balusters	73045035	73053678	73045037
Custom Width Gate Kit – 42" H – 1½" Square Balusters	73045038	73053679	73045040

Standard gate kit has a maximum opening width of 36". Custom gate kits have a maximum width opening up to 48". Gate kits include everything to build a gate panel. Gate hardware sold separately.



Standard Gate Kit

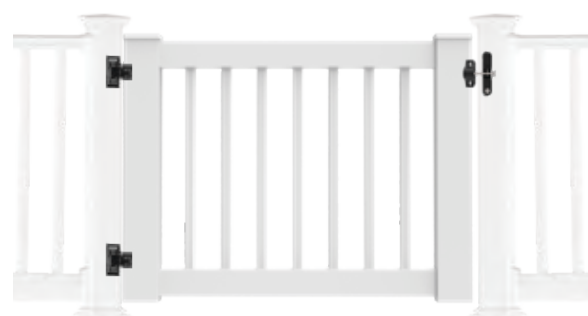

Custom Gate Kit

VINYL GATE HARDWARE

Description	Black	White
Standard Wrap Hinge Pair	73028117	73025512
Two-Sided Locking Latch	73050187	73050188
Gravity Latch	73002252	73025491
24" Heavy-Duty Drop Rod	73014305	73014306

LED lighting options are available for use with Endurance Original Rail. For details and options, see page 84.

FINYL LINE™

Finyl Line Vinyl Railing is easy to install and is reinforced with strong aluminum — designed to provide added safety. Choose from a traditional T-Top style or Deck Top profile to add a deck board to and create a flat "cocktail rail". Available with three baluster styles — square, turned or black round aluminum round aluminum and a Decorative Screen Panel* infill option.

**Decorative Screen Panels sold separately.*



PRODUCT BENEFITS

- Deck Top rail allows for deck board to be easily turned into a flat "cocktail rail"
- Aluminum stiffeners reinforce top and bottom rails for added strength and support
- Code compliant
- Made in the USA

HOMEOWNER BENEFITS

- Easy to maintain
- Transferrable Limited Lifetime Warranty

DESIGN VERSATILITY

- Decorative Screen Panel infill option offers increased customization with multiple designs and colors
- Brackets conceal all fasteners — providing a clean, finished look
- 2 top rail profile options
- 4 infill options
- Available in 3 colors

NEW!

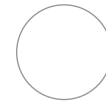

White



Clay



Sand



SOLARGUARD®

SolarGuard is a material composition that provides fade resistance* so that your outdoor living products will look good for years to come.

*Does not apply to white vinyl products.

Product Spotlight

Finyl Line Vinyl Railing is available with a code compliant Decorative Screen Panel infill option.



HOW TO SHOP:

T-TOP WITH SQUARE BALUSTERS

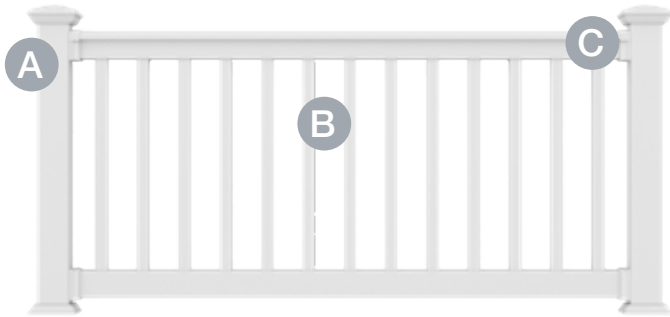

- A** Post sleeves available for wooden 4" x 4" or structural posts.
- B** Rail Kit includes top and bottom rails with aluminum stiffeners, balusters, brackets and mounting hardware.
- C** Post caps and LED post caps as well as a variety of trim rings available.

T-TOP WITH TURNED BALUSTERS

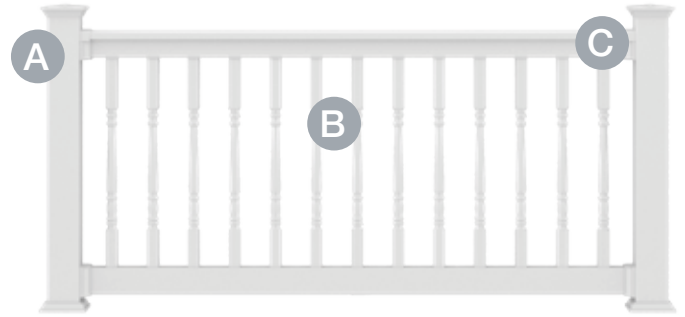

- A** Post sleeves available for wooden 4" x 4" or structural posts.
- B** Rail Kit includes top and bottom rails with aluminum stiffeners, balusters, brackets and mounting hardware.
- C** Post caps and LED post caps as well as a variety of trim rings available.

T-TOP WITH BLACK ROUND ALUMINUM BALUSTERS

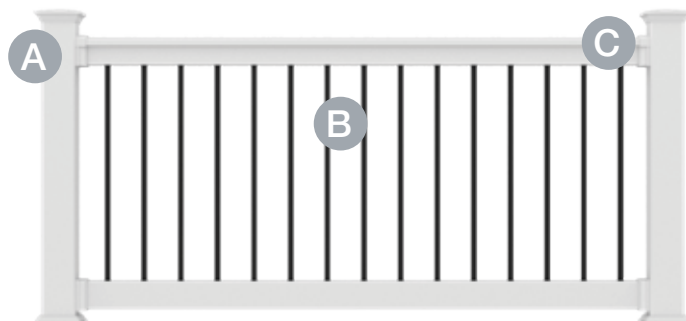

- A** Post sleeves available for wooden 4" x 4" or structural posts.
- B** Rail Kit includes top and bottom rails with aluminum stiffeners, balusters, brackets and mounting hardware.
- C** Post caps and LED post caps as well as a variety of trim rings available.

T-TOP WITH DECORATIVE INFILL (LEVEL ONLY)

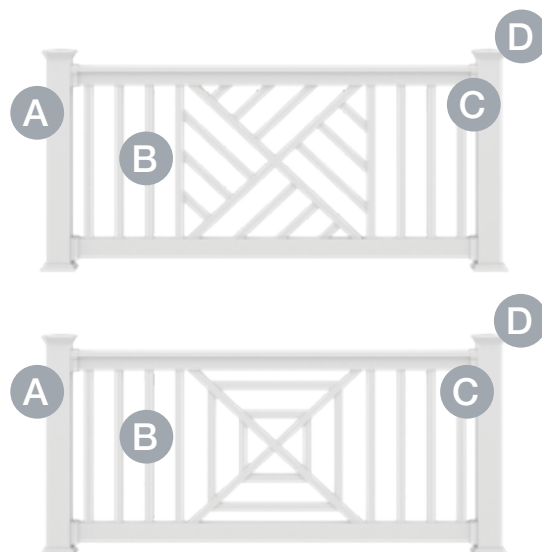

- A** Post sleeves available for wooden 4" x 4" or structural posts.
- B** Pre-assembled rail panel comes in two decorative infill styles.
- C** Brackets sold separately.
- D** Post caps and LED post caps as well as a variety of trim rings available.

HOW TO SHOP:

T-TOP WITH DECORATIVE SCREEN PANEL INFILL (LEVEL ONLY)

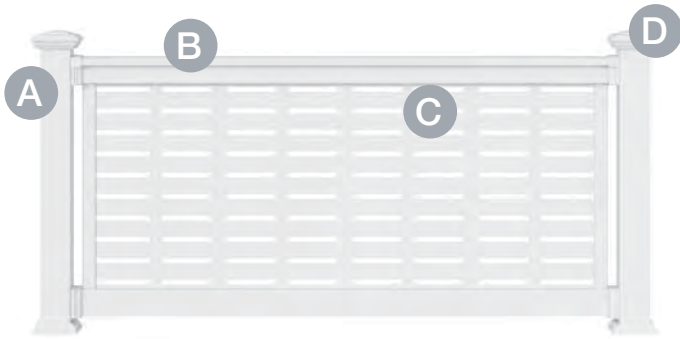

- A** Post sleeves available for wooden 4" x 4" or structural posts.
- B** Rail Kit includes top and bottom rails with aluminum stiffeners, brackets, mounting hardware and Decorative Screen Panel uprights. For 36" finished rail heights only.
- C** Decorative Screen Panel infill sold separately.
- D** Post caps and LED post caps as well as a variety of trim rings available.

DECK TOP WITH SQUARE BALUSTERS

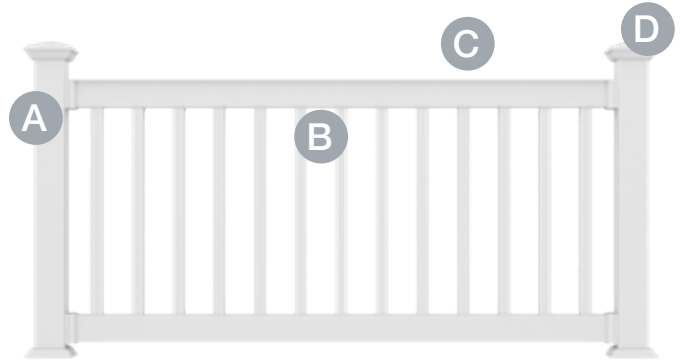

- A** Post sleeves available for wooden 4" x 4" or structural posts.
- B** Rail Kit includes top and bottom rails with aluminum stiffeners, balusters, brackets and mounting hardware.
- C** Deck board required to complete installation and sold separately.
- D** Post caps and LED post caps as well as a variety of trim rings available.

DECK TOP WITH TURNED BALUSTERS

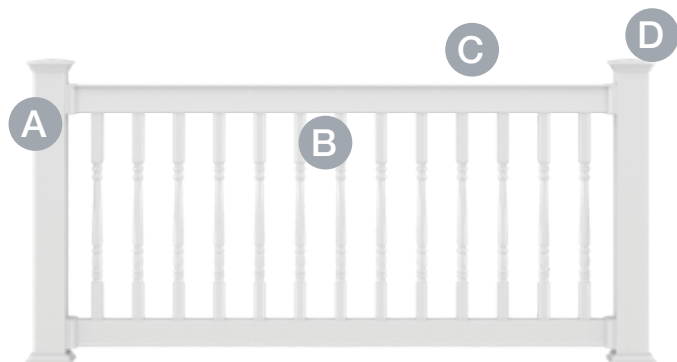

- A** Post sleeves available for wooden 4" x 4" or structural posts.
- B** Rail Kit includes top and bottom rails with aluminum stiffeners, balusters, brackets and mounting hardware.
- C** Deck board required to complete installation and sold separately.
- D** Post caps and LED post caps as well as a variety of trim rings available.

DECK TOP WITH BLACK ROUND ALUMINUM BALUSTERS

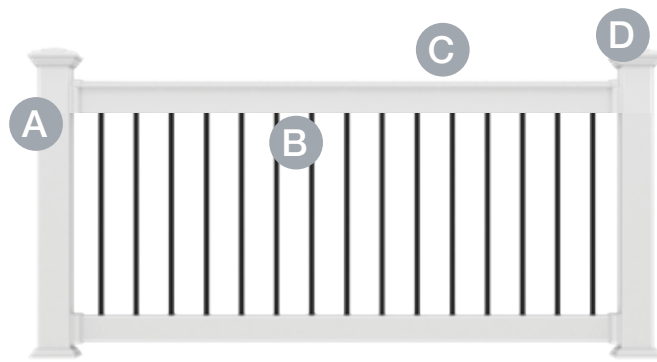

- A** Post sleeves available for wooden 4" x 4" or structural posts.
- B** Rail Kit includes top and bottom rails with aluminum stiffeners, balusters, brackets and mounting hardware.
- C** Deck board required to complete installation and sold separately.
- D** Post caps and LED post caps as well as a variety of trim rings available.

STRUCTURAL POSTS

Description	
Structural Post for 36" Rail Height – Flush Mount	73019022
Structural Post for 36" Rail Height – Thru/Fascia Mount	73019023
Structural Post for 42" Rail Height – Flush Mount	73019024
Structural Post for 42" Rail Height – Thru/Fascia Mount	73019025

VINYL POST SLEEVES & POST WRAPS

Description	White	Clay	Sand
4" x 4" x 39" Post Sleeve (unit pack of 84)	61109087	73053601	73041475
4" x 4" x 39" Post Sleeve (unit pack of 22)	73019260	N/A	N/A
4" x 4" x 45" Post Sleeve	61109088	73053602	73041476
4" x 4" x 54" Post Sleeve	73019029	N/A	N/A
4" x 4" x 100" Post Sleeve	73012479	N/A	N/A
4" x 4" x 108" Post Sleeve	61109090	73053603	73041477
4" x 4" x 120" Post Sleeve	73006803	N/A	N/A
4" x 4" x 48" Turned Post Sleeve (requires structural post)	73018760	N/A	N/A
5" x 5" x 39" Post Sleeve	73043921	N/A	N/A
5" x 5" x 45" Post Sleeve	73043922	N/A	N/A
5" x 5" x 108" Post Sleeve	73043923	N/A	N/A
5" x 5" Post Inserts*	73019139		
6" x 6" x 54" Post Sleeve	73018734	N/A	N/A
6" x 6" x 108" Post Sleeve	73018731	73053608	73041478
6" x 6" x 144" Post Sleeve	73047640	N/A	N/A
4" x 4" x 96" – 4 Piece Post Wrap**	73018473	73053604	73041479
4" x 4" x 120" – 4 Piece Post Wrap**	73018007	73053605	73041480
6" x 6" x 96" – 4 Piece Post wrap**	73018478	73053606	73041481
6" x 6" x 120" – 4 Piece Post Wrap**	73018008	73053607	73041482

*Post Inserts are used when sleeving 4" x 4" wooden posts or structural posts.

**4" x 4" Post Wrap can wrap a post from 3³/₈" square to 4¹/₈" square and 6" x 6" Post Wrap can wrap a post from 5⁷/₁₆" square to 6¹/₈" square.



Structural Post –
Flush Mount



Structural Post –
Thru/Fascia Mount



Post Sleeve



Post Insert

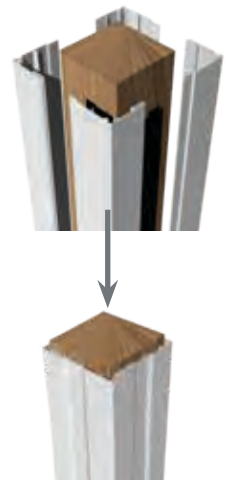

4-Piece Post Wrap

VINYL PORCH POSTS

Description	White	Clay	Sand
4" x 4" x 108" Square Post – 2,500 lb. Capacity*	73018767	N/A	N/A
4" x 4" x 108" Turned Post – 2,500 lb. Capacity*	73018752	N/A	N/A
5" x 5" x 108" Square Post – 5,000 lb. Capacity*	73018769	N/A	N/A
5" x 5" x 108" Turned Post – 5,000 lb. Capacity*	73018010	73053609	73041483
5" x 5" x 108" Premiere Square Post – 4,500 lb. Capacity**	73047642	N/A	N/A
5" x 5" x 108" Premiere Turned Post – 4,500 lb. Capacity**	73047641	N/A	N/A

*Porch Posts require a Porch Post Mounting Kit

**Premiere Posts include post mounting kits. Internal blocking not included and required if mounting railing to these posts.

PORCH POST MOUNTING KITS

Description	
4" Standard Base Kit (includes 1 bottom and 1 top mounting plate)	73018005
4" Wind Uplift Base Kit* (includes 1 bottom, 1 top mounting plate, 2 pistons and 2 PVC gaskets)	73018089
5" Standard Base Kit (includes 1 bottom and 1 top mounting plate)	73018006
5" Wind Uplift Base Kit* (includes 1 bottom, 1 top mounting plate, 2 pistons and 2 PVC gaskets)	73018090

*Wind Uplift Base Kit prevents wind uplift up to 2,800 lbs.

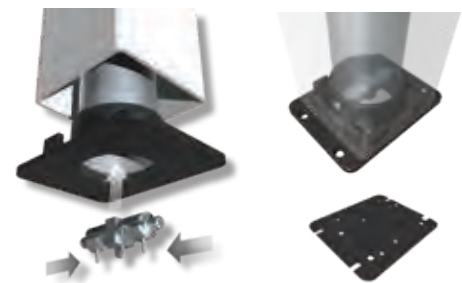
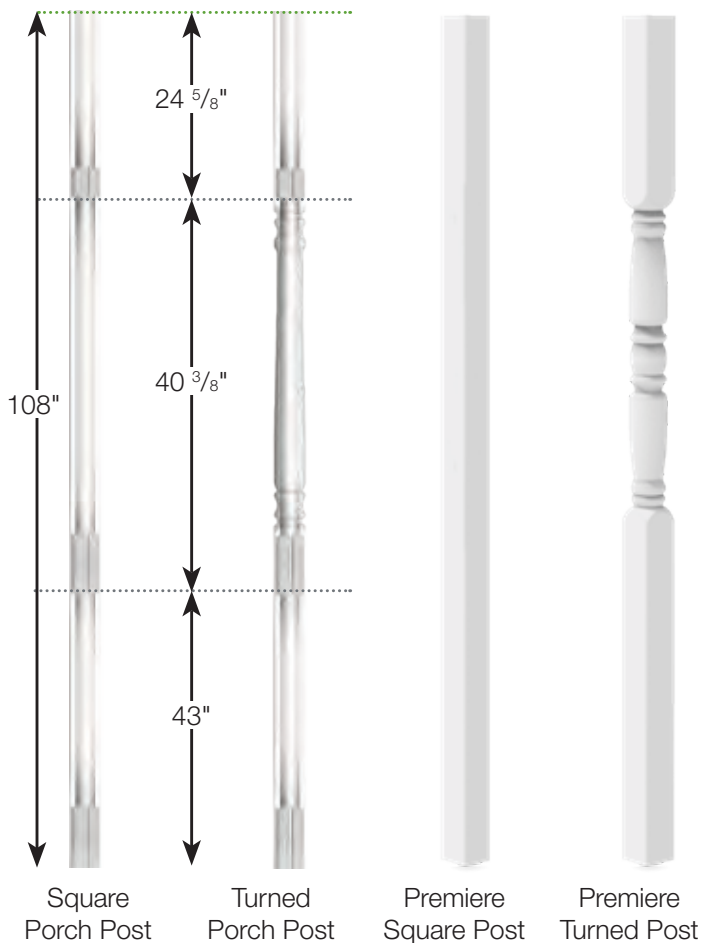

*The Wind Uplift Base Kit is shown in black for illustration purposes only. The PVC gasket prevents corrosion of the base plate and accommodates all base kits.

VINYL POST CAPS			
Description	White	Clay	Sand
4" x 4" Flat Post Cap	73018076	73053668	73041484
4" x 4" New England Post Cap	73044950	73053673	73044952
4" x 4" Elite Post Cap	73018073	73018071	73041485
4" x 4" Heritage Post Cap	73012500	N/A	N/A
4" x 4" Contemporary Post Cap	73019233	N/A	N/A
4" x 4" Contemporary Solar Post Cap	73019234	73045510	73045511
5" x 5" Flat Post Cap	73003093	N/A	N/A
5" x 5" New England Post Cap	73045003	N/A	N/A
5" x 5" Contemporary Post Cap	73013124	N/A	N/A
5" x 5" Contemporary Solar Post Cap	73013110	N/A	N/A
6" x 6" New England Post Cap	73018108	73018106	73041489
6" x 6" Elite Post Cap	73018105	N/A	N/A



Flat Post Cap

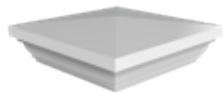

New England Post Cap



4" Elite Post Cap



6" Elite Post Cap



Heritage Post Cap



Contemporary Post Cap



Contemporary Solar Post Cap

VINYL POST TRIM RINGS			
Description	White	Clay	Sand
4" x 4" Elite Trim Ring	73018091	73018092	73041490
4" x 4" Heritage Trim Ring*	73012503	73053674	73045024
4" x 4" Low Profile Trim Ring	73045041	73053680	73045043
5" x 5" 2-Piece Trim Ring	73043929	N/A	N/A
3.5" to 6.5" – 4-Piece Elite Trim Ring**	73018131	73018066	73041493

*The Heritage Trim Ring complements the New England Post Cap and the Heritage Post Cap. Does not allow for a 2" bottom space when used with Endurance Original Rail.

**Adjustable Elite 4-Piece Trim Ring can be installed at any time and can be adjusted to fit posts from 3½" x 3½" to 6½" x 6½" without nails, screws or glue. 4-Piece Elite Trim Ring required for Wind Uplift Base Kit.



Elite Trim Ring

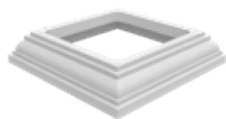

Heritage Trim Ring



Low Profile Trim Ring



5" 2-Piece Trim Ring



4-Piece Elite Trim Ring

T-TOP 1½" SQUARE BALUSTER RAIL KITS – 36" HEIGHT

Description	White	White*	Clay	Sand
4' x 36" H – Level Rail Kit	73019536	73019688	N/A	N/A
5' x 36" H – Level Rail Kit	73019560	N/A	N/A	N/A
6' x 36" H – Level Rail Kit	73019603	73019690	73053637	73041503
8' x 36" H – Level Rail Kit	73019652	73019691	73053649	73041563
10' x 36" H – Level Rail Kit	73019517	73019687	73053631	73041504
6' x 36" H – 26° to 38° Stair Rail Kit	73019599	73019600	73053639	73041505
8' x 36" H – 26° to 38° Stair Rail Kit	73019648	73019649	73053652	73041506
10' x 36" H – 26° to 38° Stair Rail Kit	73019515	N/A	N/A	N/A

*Packed in clear see-through shrink “toughpack”; all other kits boxed.

Kits include top and bottom rails with aluminum stiffeners, balusters, bracket kit, support foot (10' kits only) and installation hardware.

T-TOP 1½" SQUARE BALUSTER RAIL KITS – 42" HEIGHT

Description	White	Clay	Sand
4' x 42" H – Level Rail Kit	73019543	N/A	N/A
5' x 42" H – Level Rail Kit	73019567	N/A	N/A
6' x 42" H – Level Rail Kit	73019616	73053641	73041509
8' x 42" H – Level Rail Kit	73019665	73053656	73041510
6' x 42" H – 26° to 38° Stair Rail Kit	73019615	N/A	N/A
8' x 42" H – 26° to 38° Stair Rail Kit	73019664	73053657	73041512

Kits include top and bottom rails with aluminum stiffeners, balusters, bracket kit, support foot and installation hardware.

T-TOP 1½" TURNED BALUSTER RAIL KITS – 36" HEIGHT

Description	White	Clay	Sand
4' x 36" H – Level Rail Kit	73019537	N/A	N/A
6' x 36" H – Level Rail Kit	73019604	73053638	73041515
8' x 36" H – Level Rail Kit	73019653	73053650	73041516
10' x 36" H – Level Rail Kit	73019519	73053632	73041517
6' x 36" H – 26° to 38° Stair Rail Kit	73019601	N/A	N/A
8' x 36" H – 26° to 38° Stair Rail Kit	73019650	73053653	73041519

Kits include top and bottom rails with aluminum stiffeners, balusters, bracket kit, support foot (10' kits only) and installation hardware.



1½" Square Balusters



1½" Turned Balusters



¾" Round Aluminum Balusters

T-TOP 3/4" ROUND ALUMINUM BALUSTER RAIL KITS – 36" HEIGHT			
Description	White	Clay	Sand
4' x 36" H – Level Rail Kit	73019535	N/A	N/A
6' x 36" H – Level Rail Kit	73019602	73053636	73041522
8' x 36" H – Level Rail Kit	73019651	73053648	73041523
10' x 36" H – Level Rail Kit	73019516	73053630	73041524
6' x 36" H – 26° to 38° Stair Rail Kit	73019598	N/A	N/A
8' x 36" H – 26° to 38° Stair Rail Kit	73019647	73053651	73041526

Kits include top and bottom rails with aluminum stiffeners, balusters, bracket kit, support foot (10' kits only) and installation hardware.

T-TOP DECORATIVE INFILL PRE-BUILT PANELS – 36" HEIGHT	
Description	White
6' x 36" H – Chippendale Level Rail Panel	73047634
8' x 36" H – Chippendale Level Rail Panel	73047635
10' x 36" H – Chippendale Level Rail Panel	73047636
6' x 36" H – Freeport Level Rail Panel	73047637
8' x 36" H – Freeport Level Rail Panel	73047638
10' x 36" H – Freeport Level Rail Panel	73047639

Decorative infill SKUs come as pre-built panels. Brackets not included with rail panels; must be purchased separately.

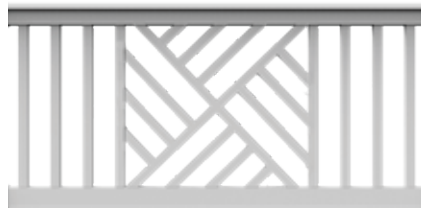

Chippendale

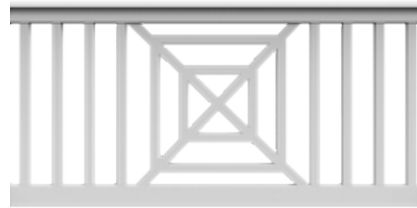

Freeport

T-TOP LEVEL RAIL KIT FOR 3' X 6' DECORATIVE SCREEN PANEL INFILL			
Description	White	Clay	Sand
6' x 36" H – Level Rail Kit	73050461	73054371	73050463

Decorative Screen Panels to use as infill sold separately. See page 88 for all 3' x 6' Decorative Screen Panel options.



Level Rail Kit with Decorative Screen Panel infill (sold separately)

DECK TOP 1½" SQUARE BALUSTER RAIL KITS – 36" HEIGHT

Description	White	Clay	Sand
6' x 36" H – Level Rail Kit	73019584	73053634	73041529
8' x 36" H – Level Rail Kit	73019633	73053643	73041530
10' x 36" H – Level Rail Kit	73019518	N/A	N/A
6' x 36" H – 26° to 38° Stair Rail Kit	73019581	N/A	N/A
8' x 36" H – 26° to 38° Stair Rail Kit	73019630	73053646	73041533

Kits include top and bottom rails with aluminum stiffeners, balusters, bracket kit, support foot (10' kits only) and installation hardware.

DECK TOP 1½" SQUARE BALUSTER RAIL KITS – 42" HEIGHT

Description	White	Clay	Sand
6' x 42" H – Level Rail Kit	73019610	N/A	N/A
8' x 42" H – Level Rail Kit	73019659	N/A	N/A
8' x 42" H – 26° to 38° Stair Rail Kit	73019658	N/A	N/A

Kits include top and bottom rails with aluminum stiffeners, balusters, bracket kit and installation hardware.

DECK TOP 1½" TURNED BALUSTER RAIL KITS – 36" HEIGHT

Description	White	Clay	Sand
6' x 36" H – Level Rail Kit	73019585	N/A	N/A
8' x 36" H – Level Rail Kit	73019634	N/A	N/A
10' x 36" H – Level Rail Kit	73019508	N/A	N/A
6' x 36" H – 26° to 38° Stair Rail Kit	73019582	N/A	N/A
8' x 36" H – 26° to 38° Stair Rail Kit	73019631	N/A	N/A

Kits include top and bottom rails with aluminum stiffeners, balusters, bracket kit, support foot (10' kits only) and installation hardware.

DECK TOP ¾" ROUND ALUMINUM BALUSTER RAIL KITS – 36" HEIGHT

Description	White	Clay	Sand
6' x 36" H – Level Rail Kit	73019583	73053633	73041549
8' x 36" H – Level Rail Kit	73019632	73053642	73041550
10' x 36" H – Level Rail Kit	73019507	N/A	N/A
6' x 36" H – 26° to 38° Stair Rail Kit	73019580	N/A	N/A
8' x 36" H – 26° to 38° Stair Rail Kit	73019629	73053645	73041553

Kits include top and bottom rails with aluminum stiffeners, balusters, bracket kit, support foot (10' kits only) and installation hardware.

T-TOP BRACKET KITS

Description	White	Clay	Sand
Level Bracket Set (2 top and 2 bottom brackets)	73019685	73019681	73041560
Stair Bracket Set (2 top and 2 bottom brackets)	73019686	73019682	73041561
Swivel Stair Bracket Set (2 top and 2 bottom brackets)	73018804	N/A	N/A
Swivel Level-Angle Bracket Set (2 top and 2 bottom brackets)	73018805	N/A	N/A
Angle Bracket Set (1 pair – cut to desired angle)	73021923	73021924	73041562



T-Top Level Brackets



T-Top Stair Brackets (26° to 38°)



T-Top Swivel Stair Brackets (0° to 45°)



T-Top Swivel Level-Angle Brackets (0° to 44°)



T-Top Angle Brackets

DECK TOP BRACKET KITS

Description	White	Clay	Sand
Level Bracket Set (2 top and 2 bottom brackets)	73019670	73019666	73041554
Stair Bracket Set (2 top and 2 bottom brackets)	73019671	73019667	73041555
Angle Bracket Set (1 pair – cut to desired angle)	73021926	73021927	73041556



Deck Top Level Brackets



Deck Top Stair Brackets (26° to 38°)



Deck Top Angle Brackets

COLUMN & ANGLE ADAPTERS

Description	White	Clay	Sand
8" Round Column Adapter (2 pack)	73019680	73019674	73041557
22.5° Angle Adapter (1 top and 1 bottom brackets)	73019678	73019672	73041559
45° Angle Adapter (1 top and 1 bottom brackets)	73019679	73019673	73041558



Round Column Adapter for 8" Columns



22.5° Adapter



45° Adapter

VINYL RAIL GATE KITS			
Description	White	Clay	Sand
Standard Width Gate Kit – 36" H – 1¼" Square Balusters	73018135	N/A	N/A
Custom Width Gate Kit – 36" H – 1¼" Square Balusters	73045025	73053675	73045027
Custom Width Gate Kit – 36" H – 1½" Square Balusters	73045028	73053676	73045030
Custom Width Gate Kit – 36" H – 1¼" Turned Balusters	73045034	N/A	N/A
Custom Width Gate Kit – 36" H – 1½" Turned Balusters	73045044	73053681	73045046
Custom Width Gate Kit – 36" H – ¾" Round Aluminum Balusters	73045031	73053677	73045033
Custom Width Gate Kit – 42" H – 1¼" Square Balusters	73045035	73053678	73045037
Custom Width Gate Kit – 42" H – 1½" Square Balusters	73045038	73053679	73045040

Standard gate kit has a maximum opening width of 36". Custom gate kits have a maximum width opening up to 48". Gate kits include everything to build a gate panel. Gate hardware sold separately.



Standard Gate Kit

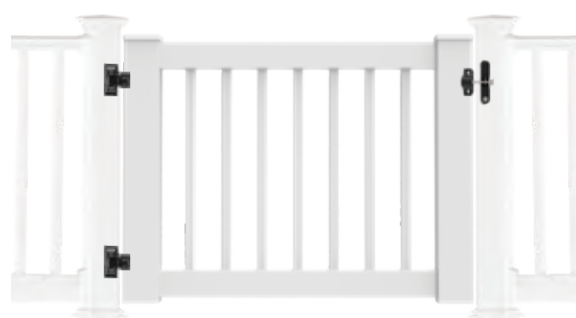

Custom Gate Kit

VINYL GATE HARDWARE		
Description	Black	White
Standard Wrap Hinge Pair	73028117	73025512
Two-Sided Locking Latch	73050187	73050188
Gravity Latch	73002252	73025491
24" Heavy-Duty Drop Rod	73014305	73014306

LED lighting options are available for use with Finyl Line. For details and options, see page 84.

TITAN PRO RAIL®

Titan Pro Rail Vinyl Railing — created with the installer in mind — features rail sections that assemble in minutes and metal-to-metal connections that are engineered for easy and safe installation. Panels are supported by structural steel posts clad in low-maintenance vinyl. Titan Pro Rail is ideal for residential and commercial applications.



PRODUCT BENEFITS

- Metal-to-metal connections for maximum strength
- Structural steel posts feature pre-attached brackets
- Code compliant
- Made in the USA

HOMEOWNER BENEFITS

- Structural steel vinyl-clad posts provide superior strength and support
- Easy to maintain
- Transferrable Limited Lifetime Warranty

DESIGN VERSATILITY

- Hidden fasteners provide a clean, finished look
- Available in 2 colors

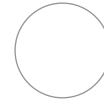

White



Clay



SOLARGUARD®

SolarGuard is a material composition that provides fade resistance* so that your outdoor living products will look good for years to come.

*Does not apply to white vinyl products.



HOW TO SHOP:

SQUARE BALUSTERS WITH TITAN POSTS

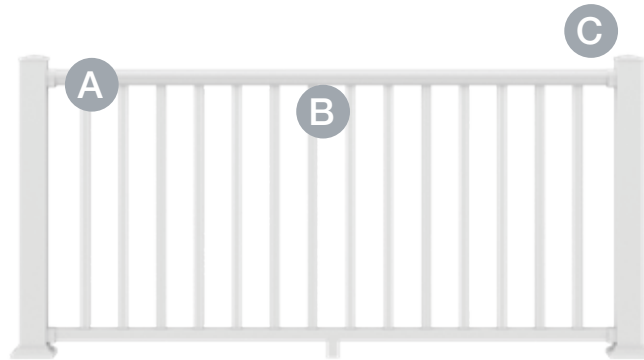

- A** Titan Pro Rail posts include a flush mount steel post insert with vinyl sleeve and pre-attached brackets (except blank post) in White only.
- B** Rail Kit contains top and bottom rails with aluminum stiffeners, balusters and a support foot. Brackets included with posts or sold separately if needed.
- C** Post caps must be purchased separately – choose from 2 styles, White only.

SQUARE BALUSTERS WITH VINYL POSTS

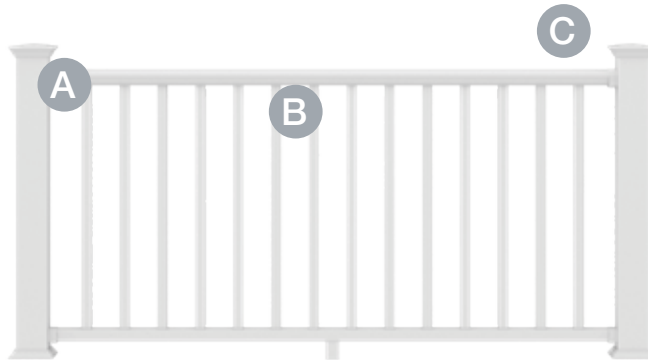

- A** Post sleeves available for wooden 4" x 4" or structural posts in both White and Clay.
- B** Rail Kit contains top and bottom rails with aluminum stiffeners, balusters and a support foot. Brackets sold separately and required.
- C** Post caps and LED post caps as well as a variety of trim rings available for 4" x 4" sleeved post options.

POST KITS – WITH 2" BOTTOM SPACE

Description	White
3.4" x 3.4" x 38.125" Blank Post Assembly for 36" Railing Height	73018657
3.4" x 3.4" x 38.125" End Post Assembly for 36" Railing Height	73018662
3.4" x 3.4" x 38.125" Mid Post Assembly for 36" Railing Height	73018664
3.4" x 3.4" x 38.125" Corner Post Assembly for 36" Railing Height	73018660
3.4" x 3.4" x 44.125" Blank Post Assembly for 42" Railing Height	73018658
3.4" x 3.4" x 44.125" End Post Assembly for 42" Railing Height	73018663
3.4" x 3.4" x 44.125" Mid Post Assembly for 42" Railing Height	73018665
3.4" x 3.4" x 44.125" Corner Post Assembly for 42" Railing Height	73018661
3.4" x 3.4" x 50.125" Blank Post Assembly for 42" Railing Height (for stairs)	73018659

Post kits include steel post insert, vinyl sleeve, brackets with covers (except blank posts), trim ring and two vinyl shims. Titan Posts with sleeve are 3.4" x 3.4" square and bottom brackets are set for a 2" bottom space.



Blank Post



End Post



Mid Post



Corner Post

POST ACCESSORIES

Description	White
Flat Post Cap	73018242
Decorative Post Cap	73018240

For other post options (including 4" x 4", 5" x 5", 6" x 6" and structural posts) and additional accessories if not using a Titan post, see our vinyl posts and post accessories on page 42. Only the Low Profile or 4-piece Adjustable trim ring provide sufficient clearance for Titan bottom brackets.



Flat Cap



Decorative Cap

RAIL KITS – 1¼" SQUARE BALUSTER

Description	White	Clay
6' x 36" H – Level Rail Kit	73018163	73053612
8' x 36" H – Level Rail Kit	73018012	73053614
10' x 36" H – Level Rail Kit	73018157	73053610
6' x 36" H – 32° to 38° Stair Rail Kit	73018200	73053616
8' x 36" H – 32° to 38° Stair Rail Kit	73018207	N/A
6' x 42" H – Level Rail Kit	73018167	73053613
8' x 42" H – Level Rail Kit	73018173	73053615
10' x 42" H – Level Rail Kit	73018161	73053611
6' x 42" H – 32° to 38° Stair Rail Kit	73018204	73053617
8' x 42" H – 32° to 38° Stair Rail Kit	73018211	N/A

Brackets not included in rail kits. Titan posts come with pre-attached brackets for ease of install for level applications; if not using Titan posts, level brackets must be purchased separately from your rail kit. Stair brackets sold separately.



1¼" Square Balusters

BRACKET ACCESSORIES		
Description	White	Clay
Level Bracket Kit – 2 Pair (4 steel brackets and 4 vinyl bracket covers)	73018011	73018228
Stair Bracket Kit – 2 Pair (4 steel brackets and 4 vinyl bracket covers)	73018229	73018232
No-Cut Stair Bracket Kit – 2 Pair	73018230	73018231
45° Bracket Adapter Kit – 1 Pair	73018225	73018226
22.5° Bracket Adapter Kit – 1 Pair	73018223	73018224
Round Column Adapter Kit – 1 Pair	73018251	N/A
Level Bracket Attachment Jig	73018227	
2-Piece Trim Ring*	73018915	

*Titan posts include 2-piece trim ring; if a replacement is needed, this item can be ordered.



Level Bracket Kit



Stair Bracket Kit

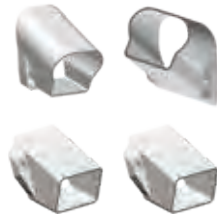

No-Cut Stair Bracket Kit



45° Bracket Adapter



22.5° Bracket Adapter



Round Column Adapter
for 8" Columns



2-Piece Trim Ring



Bracket Jig

VINYL RAIL GATE KITS

Description	White	Clay
Standard Width Gate Kit – 36" H – 1¼" Square Balusters	73018135	N/A
Custom Width Gate Kit – 36" H – 1¼" Square Balusters	73045025	73053675
Custom Width Gate Kit – 42" H – 1¼" Square Balusters	73045035	73053678

Standard gate kit has a maximum opening width of 36". Custom gate kits have a maximum width opening up to 48". Gate kits include everything to build a gate panel. Gate hardware sold separately.



Standard Gate Kit



Custom Gate Kit

VINYL GATE HARDWARE

Description	Black	White
Standard Wrap Hinge Pair	73028117	73025512
Two-Sided Locking Latch	73050187	73050188
Gravity Latch	73002252	73025491
24" Heavy-Duty Drop Rod	73014305	73014306

LED lighting options are available for use with Titan Pro Rail. For details and options, see page 84.

VINYL ADA HANDRAIL

Vinyl ADA Handrail is a code compliant graspable handrail that provides added safety and security to stairs and ramps. Featuring versatile components and metal-to-metal connections for maximum strength, this system can be joined in many different configurations.



PRODUCT BENEFITS

- Metal-to-metal connections for maximum strength
- Versatile components that can accommodate angles up to 90°
- Code compliant

HOMEOWNER BENEFITS

- Easy to maintain
- Transferrable Limited Lifetime Warranty

DESIGN VERSATILITY

- Available in 2 colors

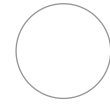

White



Clay



SOLARGUARD®

SolarGuard is a material composition that provides fade resistance* so that your outdoor living products will look good for years to come.

*Does not apply to white vinyl products.



VINYL ADA HANDRAIL

VINYL ADA HANDRAIL – LINEALS

Description	White	Clay
120" Vinyl Clad Aluminum Handrail	73018380	73018808
104" Vinyl Clad Aluminum Handrail	73018377	73018806
80" Vinyl Clad Aluminum Handrail	73018381	73018810
180° Return Loop	73018392	73018818



Vinyl Clad Aluminum Handrail



180° Return Loop

VINYL ADA HANDRAIL – MOUNTING BRACKETS

Description	White	Clay
Mounting Bracket	73018384	73018812
Inside Corner Mounting Bracket	73018394	73018820
90° Post Return	73018398	73018824
Straight Wall Return	73018402	73018826

A mounting bracket is required every 6' of Handrail lineal. Hardware to attach mounting brackets to lineals included; hardware to attach to posts not included.



Mounting Bracket



Inside Corner Mounting Bracket



90° Post Return



Straight Wall Return

VINYL ADA HANDRAIL – JOINERS

Description	White	Clay
90° Corner	73018386	73018814
Internal Adjustable Joiner (no color)	73018382	
Internal Straight Joiner (no color)	73018399	



90° Corner



Internal Adjustable Joiner

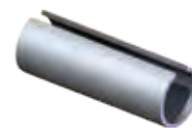

Internal Straight Joiner

VINYL ADA HANDRAIL – ACCESSORIES

Description	White	Clay
Joint Ring	73018396	73018822
End Cap	73018390	73018816



Joint Ring



End Cap

HOW TO SHOP

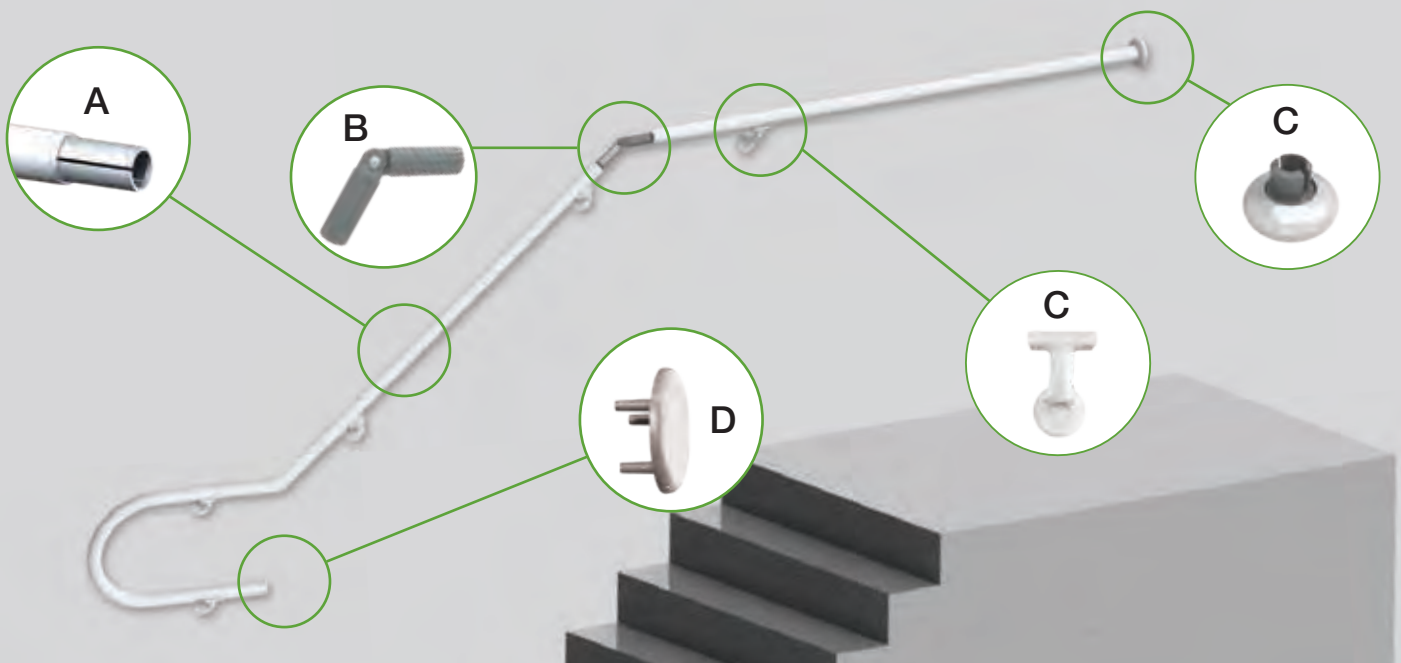

- A** ADA Handrail lineals are available in multiple lengths as well as a 180° return loop to meet ADA graspability requirements.
- B** Internal adjustable joiner allows you to create the angle you need from 0° to 90°.
- C** Mounting brackets attach to your wall or rail posts to support Handrail lineals. Returns terminate the lineal to your wall or post.
- D** Complete your install with accessories like the Handrail end cap to hide lineal ends for a finished look.

ALUMINUM ADA HANDRAIL

Aluminum ADA Handrail is the perfect solution for applications where durable, low-maintenance, graspable metal handrail is desired. Strong, metal-to-metal connections ensure dependable safety and security for any stair or ramp that requires ADA code compliance.



PRODUCT BENEFITS

- Metal-to-metal connections for maximum strength
- Versatile components that can accommodate angles up to 90°
- Code compliant

HOMEOWNER BENEFITS

- Premium powder coating meets and exceeds AAMA 2604 specifications
- Advanced weather testing, including 10,000 hours of salt spray testing
- Easy to maintain
- Transferrable Limited Lifetime Warranty

DESIGN VERSATILITY

- Powder coated colors match and complement both Avalon Aluminum Railing and MetalWorks Excalibur railing
- Available in 4 colors



SOLARGUARD®

SolarGuard is a material composition that provides fade resistance* so that your outdoor living products will look good for years to come.

*Does not apply to white vinyl products.



ALUMINUM ADA HANDRAIL

ALUMINUM ADA HANDRAIL – LINEALS

Description	White	Matte Black	Hammered Bronze	Matte Bronze
1½" x 80" Aluminum Lineal	73019171	73019169	73019170	73041311
1½" x 104" Aluminum Lineal	73019175	73019173	73019174	73041309
1½" x 120" Aluminum Lineal	73019179	73019177	73019178	73041310
180° Return Loop	73019227	73019229	N/A	73041325



Aluminum Handrail



180° Return Loop

ALUMINUM ADA HANDRAIL – MOUNTING BRACKETS

Description	White	Matte Black	Hammered Bronze	Matte Bronze
Mounting Bracket	73019151	73019149	73019150	73041323
Mounting Bracket for Vinyl Posts	N/A	73042847	N/A	N/A
Inside Corner Mounting Bracket	73041318	73041317	N/A	73041315
90° Post Return	73019147	73019145	73019146	73041324
90° Post Return for Vinyl Posts	N/A	73042848	N/A	N/A
Straight Wall Return	73019155	73019153	73019154	73041326

A mounting bracket is required every 6' of Handrail lineal. Hardware to attach mounting brackets to steel or aluminum posts included and hardware for vinyl posts included in brackets indicating use for vinyl posts.



Mounting Bracket



Mounting Bracket for Vinyl Posts



Inside Corner Mounting Bracket



90° Post Return



90° Post Return for Vinyl Posts



Straight Wall Return

ALUMINUM ADA HANDRAIL – JOINERS

Description	White	Matte Black	Hammered Bronze	Matte Bronze
External Adjustable Joiner	73019167	73019165	73019166	73041314
Internal Straight Joiner (no color)	73018399			
90° Corner	73019163	73019161	73019162	73041312



External Adjustable Joiner



Internal Straight Joiner



90° Corner

ALUMINUM ADA HANDRAIL – ACCESSORIES

Description	White	Matte Black	Hammered Bronze	Matte Bronze
End Cap	73019159	73019157	73019158	73041313
Joint Ring	73041322	73041321	N/A	73041319
Spacer Block*	73041469	73042849	N/A	73043094

*Spacer Block is ¼" thick and used to help block out brackets for narrower, 2" Over-the-Top in-line Avalon posts installed between standard 2½" Avalon posts.



End Cap



Joint Ring



Spacer Block

HOW TO SHOP

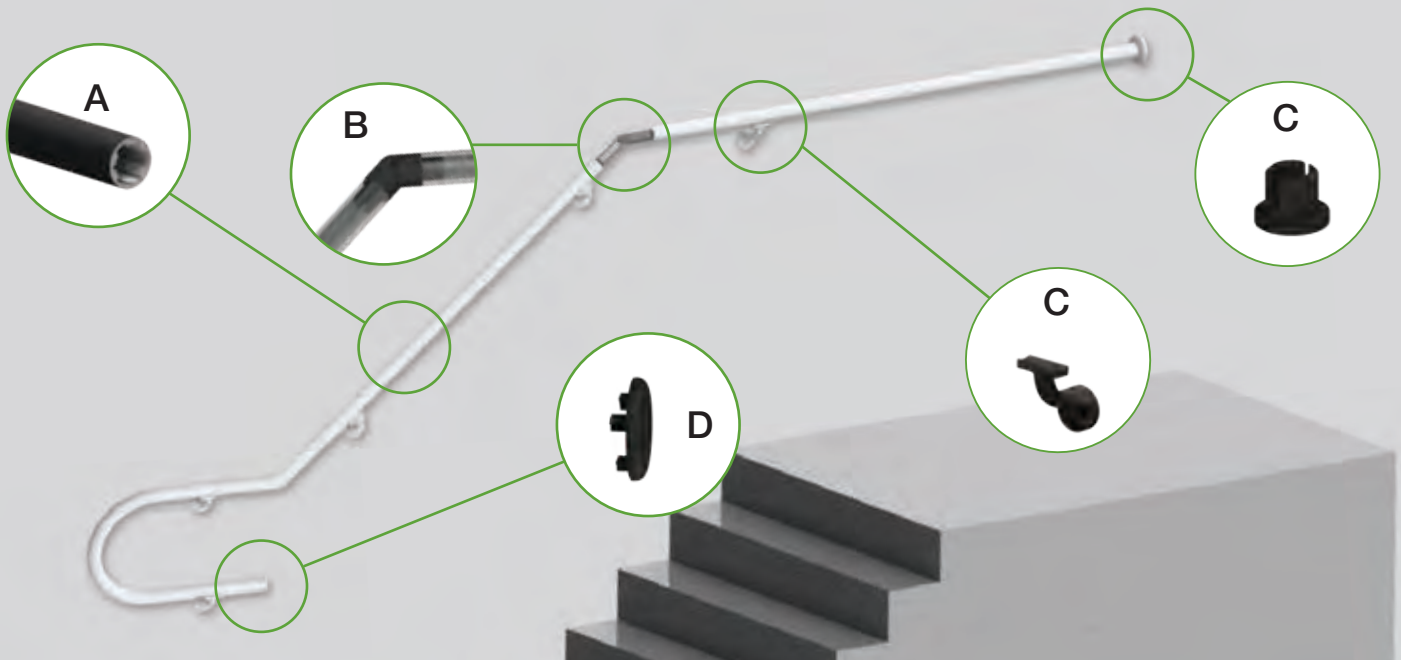

- A** ADA Handrail lineals are available in multiple lengths as well as a 180° return loop to meet ADA graspability requirements.
- B** Our innovative external adjustable jointer fits securely into the lineals & allows installations of angles up to 45°.
- C** Mounting brackets attach to wall or rail posts to support Handrail lineals. Cast aluminum straight return fits neatly into the lineal and terminates the lineal to any wall or post.
- D** Complete your install with accessories like the Handrail end cap to hide lineal ends for a finished look.

LIGHTING

Solar Post Caps and a full LED Lighting system are available for use with all Barrette Outdoor Living vinyl, aluminum and steel railing products. Under-rail LED lighting strips feature an adhesive backing and easily connect with a 50W Bluetooth compatible transformer. Additional LED accessories include post caps, dome lights, flush deck and side/stair lights.

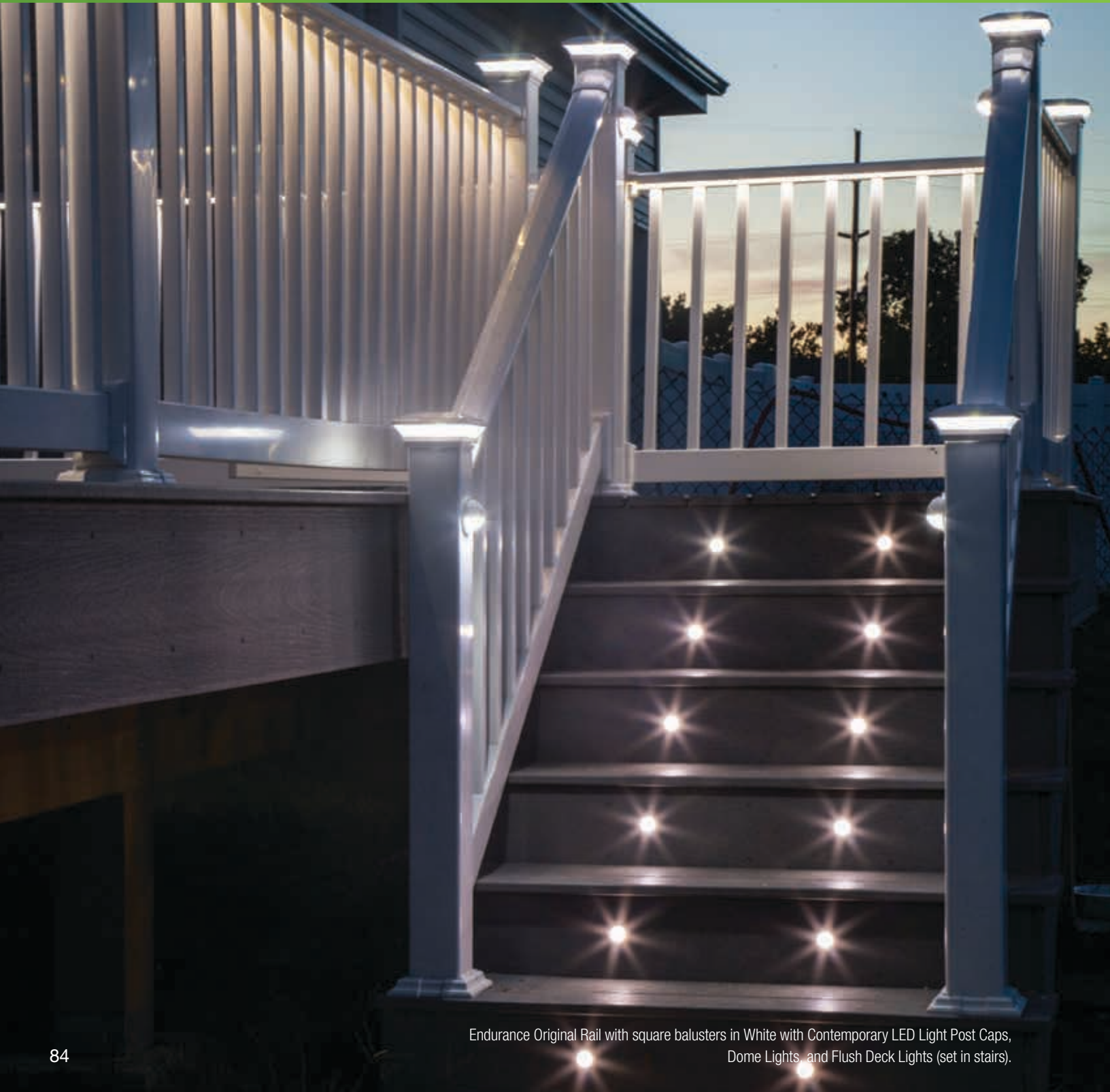

Endurance Original Rail with square balusters in White with Contemporary LED Light Post Caps, Dome Lights, and Flush Deck Lights (set in stairs).

PRODUCT BENEFITS

- LED plug-and-play lighting system does not require cutting or splicing of wires
- Under-rail light channel available for certain railing styles
- 2- and 5-way splitters and additional lighting wire available

HOMEOWNER BENEFITS

- Long-lasting, true white LED lights — rated at 50,000 hours
- Adjust and control lighting with smartphone*
- Limited Warranty

**available only with transformer*

DESIGN VERSATILITY

- Post cap and/or under-rail LED lighting options
- Color matched post caps available for most railing styles
- Solar post caps with down lighting available for dramatic lighting effect

Product Spotlight

Bluetooth compatible transformer for LED lighting can be controlled on your smartphone!



Transform posts and top rail in Caramel with Avalon Aluminum Railing infill in Matte Black with Under-Rail LED Lighting.

ALUMINUM RAIL – LIGHTED ACCESSORIES

Description	White	Matte Black	Matte Bronze
2½" 3-in-1 LED Light Post Cap (1.6W)	73021946	73021947	73021948
2½" Solar Light Post Cap	73044955	73044954	73044941
2½" Solar Down Light Post Cap	73044936	73044935	73044953
4¼" Solar Light Post Cap	73050527	73050526	73050528
4¼" LED Light Post Cap (0.80W)	73050524	73050523	73050525
92" Under-Rail LED Lighting (3W for 92" length)	73019376		
Flush Deck Light (0.40W)	73019403		



3-in-1 LED Light Post Cap



Solar Light Post Cap



Solar Down Light Post Cap

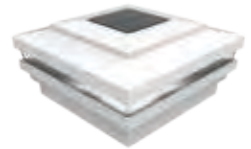

4¼" Solar Light Post Cap



4¼" LED Light Post Cap



92" Under-Rail LED Lighting (3W)



Flush Deck Light (0.40W)

STEEL RAIL – LIGHTED ACCESSORIES

Description	Matte Black
2" LED Post Cap (0.80W)	73043000
3" LED Post Cap (0.80W)	73043001
2" Solar Down Light Post Cap	73044933
3" Solar Down Light Post Cap	73044934
Flush Deck Light (0.40W)	73019403

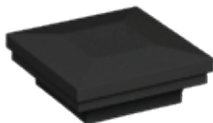

LED Lighted Post Cap (2" or 3")

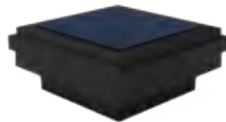

Solar Down Light Post Cap (2" or 3")



Flush Deck Light (0.40W)

VINYL RAIL – LIGHTED ACCESSORIES

Description	White	Clay	Sand
4" x 4" Contemporary Solar Post Cap	73019234	73045510	73045511
4" x 4" Contemporary LED Post Cap (0.80W)	73019377	73045506	73045507
5" x 5" New England LED Post Cap (0.80W)	73043928	N/A	N/A
5" x 5" Contemporary Solar Post Cap	73013110	N/A	N/A
Dome Light (0.80W)	73019404	73045508	73045509
Stair/Side Light (0.40W)	73019411	N/A	N/A
92" Under-Rail LED Lighting (3W for 92" length)	73019376		
Flush Deck Light (0.40W)	73019403		



Contemporary Post Cap (Solar or LED)



New England LED Post Cap (0.80W)



Dome Light (0.80W)



Side/Stair Light (0.40W)



92" Under-Rail LED Lighting (3W)



Flush Deck Light (0.40W)

LED LIGHTING – COMPONENTS

Description	SKU
Bluetooth Transformer for LED Lighting System	73041277
2-Way Splitter	73019370
5-Way Splitter	73019371
2' Electrical Lighting Wire	73032449
5' Electrical Lighting Wire	73019375
7' Electrical Lighting Wire	73019373
9' Electrical Lighting Wire	73019374
92" Under-Rail Light Channel (10 pack for use with Endurance Original Rail, Finyl Line and Titan Pro Rail) – WHITE	73024866

Transformer is 50W. Includes photocell, built-in dimmer, timer, and remote. Transformer is Bluetooth capable; "SmartPower50" app available from the App Store and Google Play.



Transformer (50W) with Bluetooth capability



2-Way Splitter



Lighting Wire – available in 2', 5', 7' or 9' lengths.



5-Way Splitter



Under-Rail Light Channel (92" length)

DECORATIVE SCREEN PANELS

Decorative Screen Panels offer a unique and attractive way to customize an indoor or outdoor setting. Allowing for creativity with privacy screening, Decorative Screen Panels are the perfect home accent to enhance a room, patio, garden or a stylish solution for under a deck. Several of our railing products also offer options to use Decorative Screen Panels as infills. Panels can also be installed up to three high in our aluminum frame kit — creating a divider screen for increased privacy wherever it is needed.



PRODUCT BENEFITS

- Low-maintenance, impact resistant material ensures stability in extreme climates
- Select designs feature a dimensional effect for added realism
- Made in the USA

HOMEOWNER BENEFITS

- Resists warping, rot, twisting, splitting, discoloration and scratching
- Can be used as decorative infill in select railing products
- Limited Lifetime Warranty

DESIGN VERSATILITY

- Available in 8 designs and 2 sizes
- Paintable
- Wide variety of color options



Black

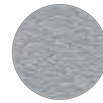

Gray



White



Brazilian Walnut



Umber



Saddle

Product Spotlight

8' x 8' Pergola incorporates Decorative Screen Panels on top — providing privacy and shade.

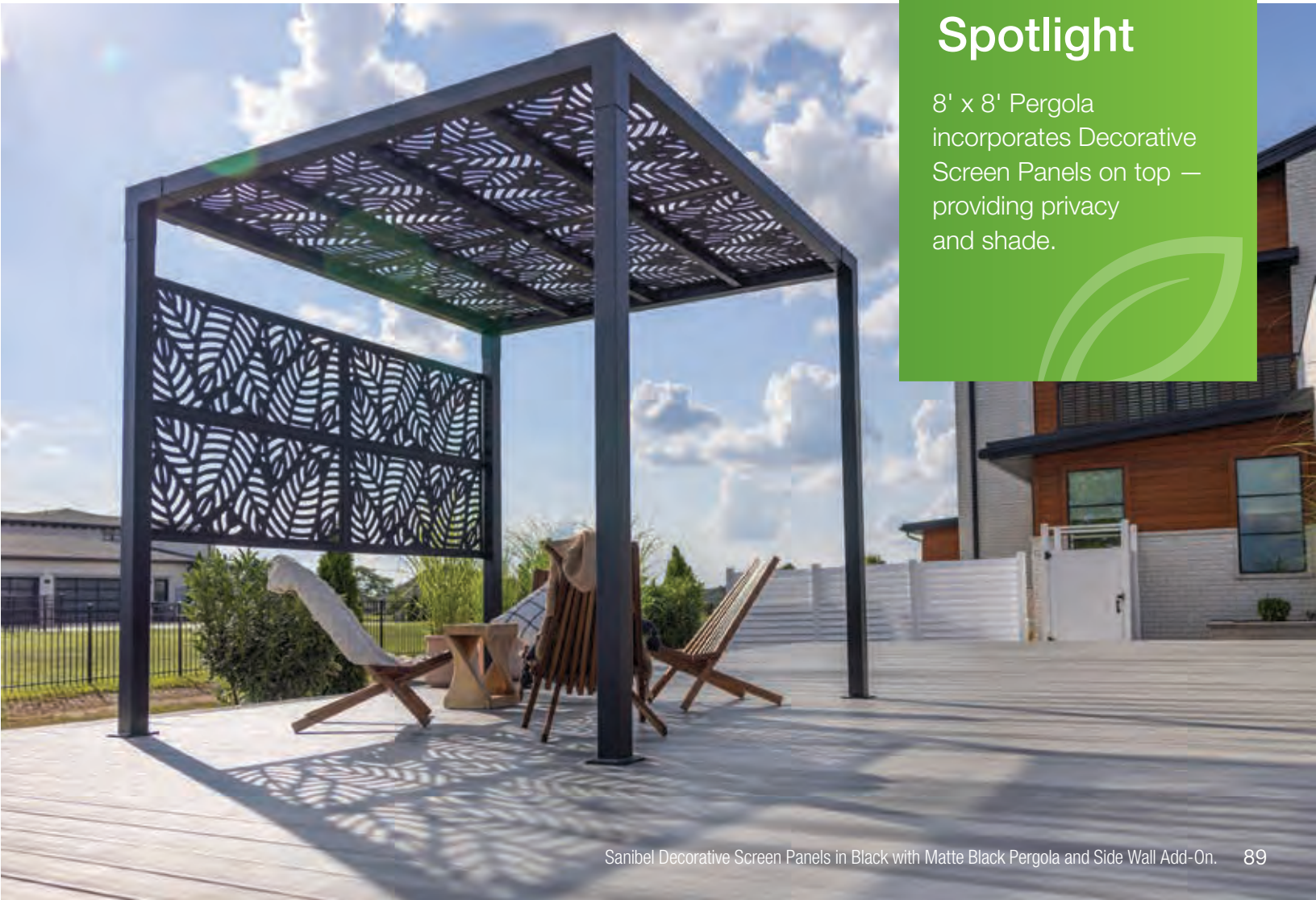

DECORATIVE SCREEN PANELS

2' X 4' DECORATIVE SCREEN PANELS				
Description	Boardwalk	Morse	Fretwork	Sprig
2' x 4' x 0.3" – White	73042821	73004795	73004785	73004790
2' x 4' x 0.3" – Gray	73050384	73050383	73050381	73050382
2' x 4' x 0.3" – Saddle	73042824	73004798	73004788	73004793
2' x 4' x 0.3" – Brazilian Walnut	N/A	N/A	N/A	73004687
2' x 4' x 0.3" – Black	73042822	73004796	73004786	73004791
Description	Sanibel		Slate	
2' x 4' x 0.3" – Umber	73050359		N/A	
2' x 4' x 0.3" – Black	73050358		73050082	

Actual size: 23.88" x 47.88" x 0.3".

3' X 6' DECORATIVE SCREEN PANELS				
Description	Boardwalk	Sanibel	River Rock	Optic
3' x 6' x 0.3" – White	73045664	N/A	73045668	N/A
3' x 6' x 0.3" – Gray	73045665	N/A	73045669	N/A
3' x 6' x 0.3" – Saddle	73045666	N/A	N/A	N/A
3' x 6' x 0.3" – Black	73030561	73050460	73045667	73050083

Actual size: 36" x 68" x 0.3".

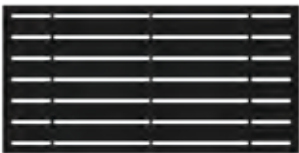

Boardwalk
US Des. Pat. No. D889,142



Morse
US Des. Pat. No. D843,607

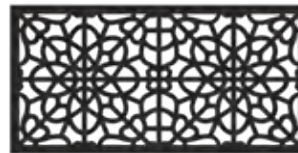

Fretwork
US Des. Pat. No. D843,608

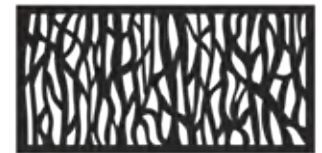

Sprig
US Des. Pat. No. D843,605



Sanibel
Design Patent Pending



Slate

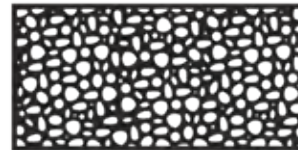

River Rock

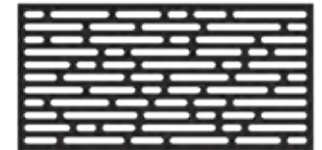

Optic

Decorative Screen Panels are designed with a matte, textured finish to allow them to be painted for complete customization.

DECORATIVE SCREEN PANEL HARDWARE	
Description	
Fastener Kit (12 stainless steel screws and 12 color matched screw covers) – White	73025526
Fastener Kit (12 stainless steel screws and 12 color matched screw covers) – Gray	73050385
Fastener Kit (12 stainless steel screws and 12 color matched screw covers) – Saddle	73025529
Fastener Kit (12 stainless steel screws and 12 color matched screw covers) – Brazilian Walnut	73004820
Fastener Kit (12 stainless steel screws and 12 color matched screw covers) – Umber	73050380
Fastener Kit (12 stainless steel screws and 12 color matched screw covers) – Black	73025527

DECORATIVE SCREEN PANEL FRAME KIT

Description	Matte Black
2' x 4' Horizontal Frame Kit (holds up to three 2' x 4' Decorative Screen Panels — sold separately)	73050431
2' x 4' Line Post Kit (use with Frame Kit to create a continuous section)	73050432
2' x 4' Corner Post Kit (use with Frame Kit to create a corner section)	73050433
3' x 6' Horizontal Frame Kit (holds up to two 3' x 6' Decorative Screen Panels — sold separately)	73050434
3' x 6' Vertical Frame Kit (holds one 3' x 6' Decorative Screen Panel — sold separately)	73050437
3' x 6' Line Post Kit (use with Horizontal or Vertical Frame Kit to create a continuous section)	73050435
3' x 6' Corner Post Kit (use with Horizontal or Vertical Frame Kit to create a corner section)	73050436

2' x 4' Decorative Screen Panel Frame Kit contains two 2 aluminum end posts, 2 top/bottom U-channels, 2 mid H-channels, surface mounting kit, post caps and hardware.

3' x 6' Decorative Screen Panel Frame Kits contain 2 aluminum end posts, 2 top/bottom U-channels, surface mounting kit, post caps and hardware.

Line and Corner Post Kits contain one 2" aluminum post (for either line or corner application), 2 top/bottom U-channels, 2 mid H-channels, surface mounting kit, post cap and hardware.



2' x 4' Frame Kit
(Decorative Screen Panels sold separately)



3' x 6' Horizontal Frame Kit
(Decorative Screen Panels sold separately)



3' x 6' Vertical Frame Kit
(Decorative Screen Panels sold separately)



Line Post Kit



Corner Post Kit

PERGOLA

Description	Matte Black
8' x 8' Pergola – Uses eight 2' x 4' Decorative Screen Panels (sold separately)	73050386
Pergola Side Wall Add-On (Includes 2 walls) – Uses eight 2' x 4' Decorative Screen Panels (sold separately)	73050387



8' x 8' Pergola
(Decorative Screen Panels sold separately)



Side Wall Add-On
(Shown with Pergola. Pergola and Decorative Screen Panels sold separately)

LATTICE

Lattice panels are the perfect way to add privacy and conceal unsightly outdoor areas. Easy to maintain and install, durable plastic lattice is resistant to termites and other wood-eating pests. Lattice maintains its classic look without the need for sanding, staining or painting. Available in classic diamond, privacy diamond and privacy square patterns.



PRODUCT BENEFITS

- Low-maintenance
- Impact resistant plastic
- Matching screws, cap molding and divider molding available
- Made in the USA

HOMEOWNER BENEFITS

- Resists warping and twisting
- Limited Lifetime Warranty

DESIGN VERSATILITY

- Available in 3 patterns
- Wide variety of color options



LATTICE

LATTICE				
Color	Classic Diamond (2' x 8')	Classic Diamond (4' x 8')	Privacy Diamond (4' x 8')	Privacy Square (4' x 8')
White	73004010	73004026	73004042	73004051
Woodland Green	N/A	73004020	73004037	N/A
Sierra Cedar	N/A	73004021	73004038	N/A
Redwood	N/A	73004023	73004040	N/A
Clay	N/A	73054359	73054360	N/A
Brazilian Walnut	N/A	73004144	73004142	N/A
Nantucket Gray	N/A	73004145	73004143	N/A
Better Than Treated	N/A	73004027	73004108	N/A
Black	N/A	73004497	73004479	73053435
NEW! Espresso	N/A	73053436	73053437	N/A

Lattice comes in a variety of color options and is NOT intended to be painted.

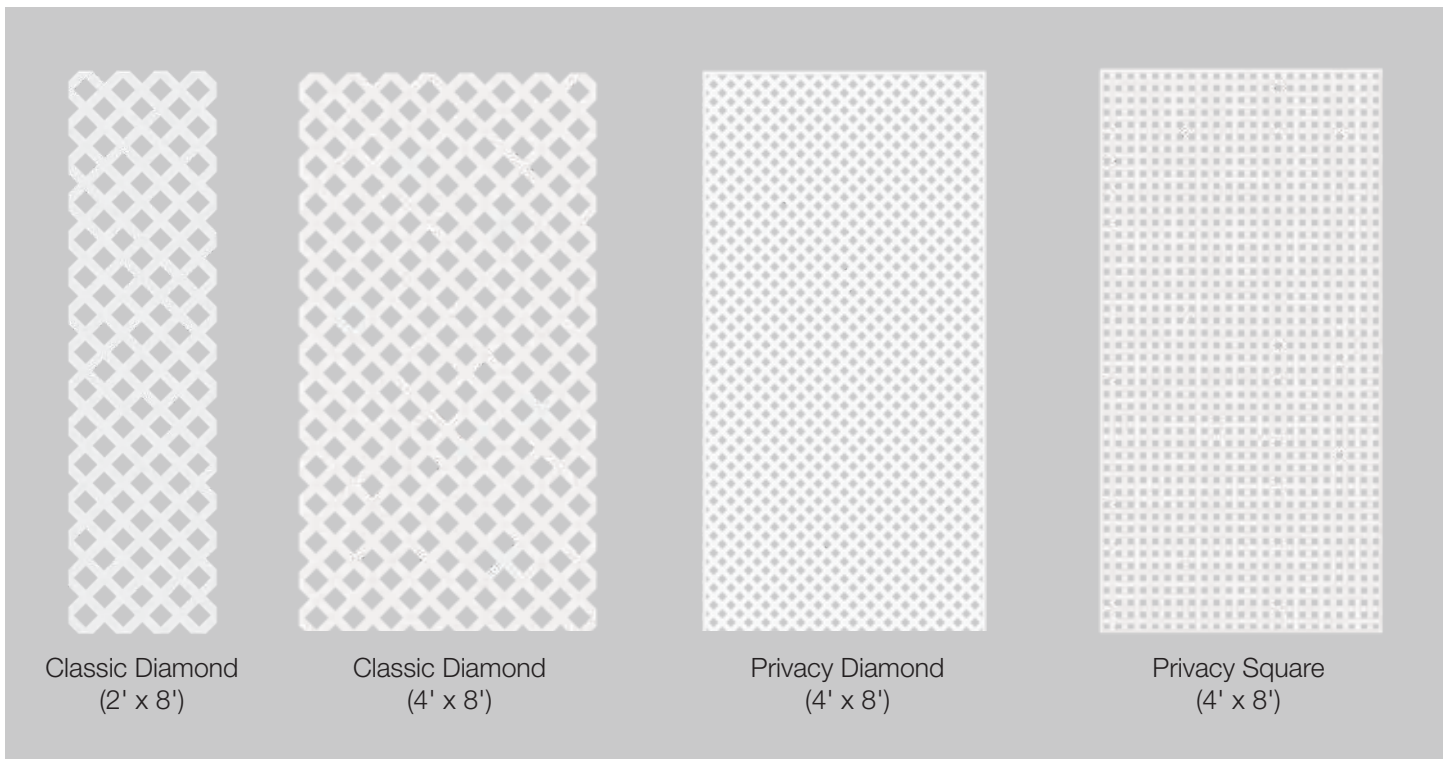

LATTICE ACCESSORIES

Color	Cap Molding	Divider Molding	1½" Color Matched Screws*
White	73004058	73004066	73003464
Woodland Green	73004057	73004079	73003466
Sierra Cedar	73004059	73004067	73003467
Redwood	73004061	73004069	73003470
Clay	73054361	73054362	73003469
Brazilian Walnut	73004140	73004138	73003999
Nantucket Gray	73004141	73004139	73013281
Better Than Treated	73004064	73004081	73003472
Black	73004496	73004477	73014290
NEW! Espresso	73053438	73053439	73053440

*Color Matched Screws are stainless steel and come in packs of 12.

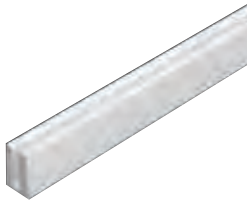

Cap Molding



Divider Molding

1½" Color Matched
Screws

rdi[®]
RAILING



SCAN ME

BY **Barrette**
OUTDOOR LIVING[®]